

Comunicazioni

Poster

Synthesis of caged proton disulphide compounds for gold nano particles functionalization

G. Sabbatella^{1,2}, S. Antonaroli¹, H. Remita³, A. Nucara⁴, M. Carbone¹

¹ Dept. of Chemical Science and Technologies, University Tor Vergata, Rome Italy, ² Dept. Of Chemistry, University La Sapienza, Rome, Italy, ³ Lab. de Chimie Physique, Université Paris Sud, UMR8000-CNRS, France, ⁴ Dept. of Physics, University La Sapienza, Rome, Italy
Email: simonetta.antonaroli@uniroma2.it

ABSTRACT

Synthesis of proton releasing compound, 1-(2-nitrophenyl)-carboxysulphamoyl-9-ennylidysulphide, and coupling of this Proton Caged Compounds (PCC) with gold nanoparticles (AuNPs) to allow the compound to be vehicle in cellular medium .

KEYWORDS: Caged Compounds, gold nanoparticles

Proton Caged Compounds (PCCs) are molecules which release protons upon irradiation at a specific wavelength. Their use has been probed on biological systems, such as the protein metmyoglobin, which changes conformation as a function of the photo-induced proton release¹.

The potential applications of photo-induced proton releasing compounds are vast. Investigations have been reported on the use of such molecules in cancer therapy² and antibiotic action³.

Performances of PCCs in varying the pH in cellular environments may be enhanced by implementing the vectorization of the compound in the cellular medium and by “focusing” the protons in localized areas within the cell. This can be achieved by coupling the PCCs with gold nanoparticles (AuNPs), reported as efficient, low cytotoxic vectors⁴ that can bind a large amount of molecules by formation of self-assembled monolayers (SEMs).

The coupling of the PCCs with AuNPs requires the functionalization of the PCCs with thiols or with disulphide groups.

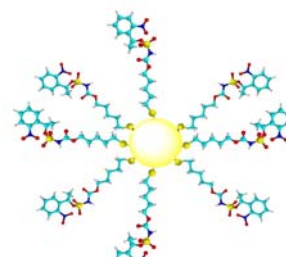

Here we report the synthesis of the purposely designed disulphided proton caged compound, the 1-(2-nitrophenyl)-carboxysulphamoyl-9-ennylidysulphide, we intend to use for cell treatments and infrared probing upon irradiation.

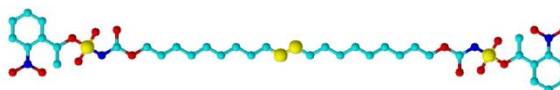

The synthesis is based on the conversion of chlorosulfonyl isocyanate, by subsequent reactions of the oxygen and chloride terminals⁵. The oxygen terminal reacts with 1,2-nitrophenylethanol to yield 1-(2-nitrophenyl)(chlorosulfonyl)carbamate. The latter compound undergoes a double substitution on the chloride terminal first with triethylamine and, then, with previously prepared disulphidedennylglycol⁶ to yield to the final product.

The disulphided-PPC is, then, functionalized with monodispersed 20 nm diameter gold nanoparticles according to the method proposed by Brust *et al.*⁷.

The proton releasing properties of the disulphided-PCC, both free and after binding of AuNPs were probed by combined UV irradiation and infrared spectroscopy.

References

- ¹ A. Barth, J.E.T. Corrie, *Biophys. J.* 2002, 83 (5), 2864.
- ² Y. Luo, C. Wang, P. Peng, M. Hossain, T. Jiang, W. Fu, Y. Liao, M. Su, *J. Mater. Chem. B* 2013, 1, 997.
- ³ X. Yue, C.O. Yanez, S. Yao, K.D. Belfield, *JACS*, 2013 135, 2112.
- ⁴ E. E. Connor, J. Mwamuka, A. Gole, C. J. Murphy, M. D. Wyatt, *SMALL* 2005, 1(3), 325.
- ⁵ E. M. Burgess, H. R. Penton, Jr., E. A. Taylor, W. M. Williams. *Organic Syntheses*, Coll. 1988, 6, 788.
- ⁶ M. H. Ali, M. McDermott *Tetrahedron Lett.*, 2002, 43, 6271.
- ⁷ M. Brust, M. Walker, D. Bethell, D. J. Schiffrin, R. Whyman, *J. Chem. Soc. Chem. Comm.* 1994, 801.

Acetophenone hydrogenation in photocatalytic membrane reactor under UV and visible light

Raffaele Molinari, Pietro Argurio, Cristina Lavorato

Department of Environmental and Chemical Engineering, University of Calabria, Via P. Bucci, 44/A, 87036, Arcavacata di Rende (CS), Italy

Email: pietro.argurio@unical.it

ABSTRACT

The hydrogenation of acetophenone to phenylethanol was carried out in a photocatalytic membrane reactor (PMR) by using water as solvent and formic acid as electron donor under UV and visible light irradiation. The use of a membrane reactor was found to improve the efficiency of the photocatalytic reaction compared to a batch reactor. Doping TiO_2 photocatalyst with Pd improved five times its photocatalytic activity under visible light irradiation. The results evidenced that performing the photocatalytic hydrogenation in membrane reactors represents a promising green method of chemical production.

Keywords: Photocatalysis, membrane reactor, acetophenone hydrogenation, phenylethanol, TiO_2 doping, visible light.

The reduction of carbonyl compounds in the corresponding alcohols is an important transformation in organic synthesis. The reduction of acetophenone to phenylethanol, which is used as a building block for the synthesis of bioactive compounds (e.g. agrochemicals, pharmaceuticals, natural products) is an important reaction due to the limited natural resources of the reduced product [1]. Photocatalytic transfer hydrogenation, using sacrificial chemicals as hydrogen and electron donor, is an alternative and more sustainable method to synthesize organic compounds operating under mild conditions and using cheaper catalysts.

The most widely used photocatalyst is titanium dioxide (TiO_2), but its use presents some important drawbacks: the electron/hole recombination and the spectrum of absorbance mainly in the UV region. Noble metal doping has been reported to be very effective in limiting these restrictions [2]. Alcohol are sacrificial reagents largely used for photocatalytic reductions, used in large excess to shift the reaction to the desired product. Formic acid is an interesting alternative since it is converted into carbon dioxide (CO_2) and hydrogen (H_2) making the reaction irreversible.

In view of large scale applications, photocatalytic membrane reactors (PMRs) can be proposed because they combine the advantage of classical photoreactors and those of membrane processes with a synergy of both technologies [3].

On the basis of this, in the present work the hydrogenation of acetophenone to phenylethanol was carried out in PMRs using water as solvent, formic acid as hydrogen and electron donor and commercial TiO_2 and homemade Pd/ TiO_2 as photocatalyst under UV and visible light, respectively.

Preliminary tests were carried out in batch to investigate the influence of some operating conditions on system performances. Better results in terms of phenylethanol yield (4.7%) were obtained in the following conditions: i) 1.5 g L^{-1} of TiO_2 ; ii) $\text{pH} = 7.5$; iii) $[\text{HCOOH}] = 1.97 \text{ M}$. These conditions were used in the following photocatalytic tests in PMRs.

The use of a PMR, obtained by coupling the batch photoreactor with a membrane contactor (Figure 1), was found to improve the efficiency of the photocatalytic reaction compared to a batch reactor (Table 1). This behaviour is due to the extraction of produced phenylethanol in the organic extracting phase, shifting the hydrogenation reaction forward to the product and allowing to limit over hydrogenations. The most efficient system was found to be the PMR in which acetophenone was used as both extracting organic phase and substrate reservoir.

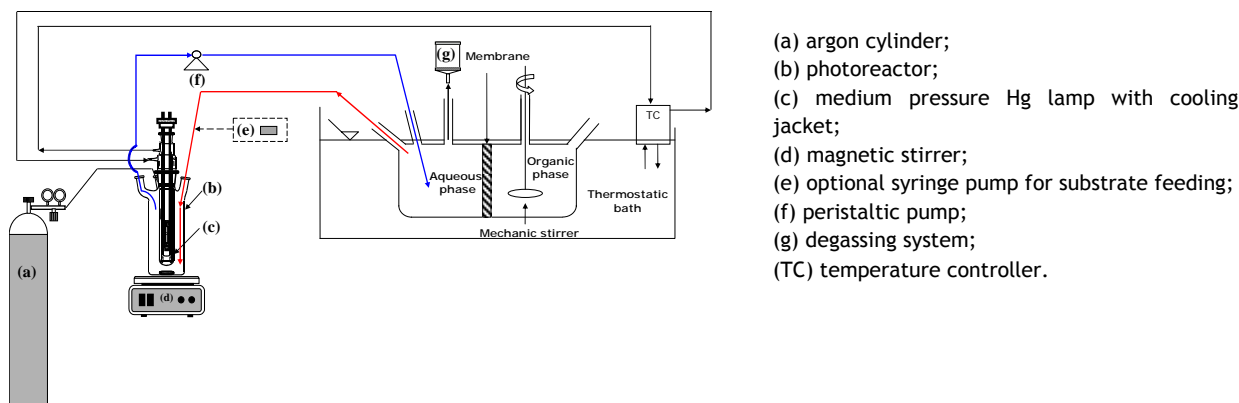

(a) argon cylinder;
 (b) photoreactor;
 (c) medium pressure Hg lamp with cooling jacket;
 (d) magnetic stirrer;
 (e) optional syringe pump for substrate feeding;
 (f) peristaltic pump;
 (g) degassing system;
 (TC) temperature controller.

Figure 1: Scheme of the membrane contactor integrated with batch photoreactor.

Table 1: Summary of the results obtained in the photocatalytic tests by using batch and PMR systems (recirculating flow rate = 166 mL min⁻¹, T = 32 °C, 7 hours).

	Produced phenylethanol (μmol)	Productivity (mg g ⁻¹ h ⁻¹)	Extraction (%)
Batch	184.23	2.96	NA*
PMR	276.20	4.44	21.91

*NA: not applicable

Commercial TiO₂ showed a negligible activity under visible light (Table 2). The photocatalytic activity under visible light was significantly implemented by its doping with palladium. The amount of produced phenylethanol (1371 μmol) and the productivity (22.02 mg g⁻¹h⁻¹) by using Pd/TiO₂ photocatalyst under visible light were found to be five times higher than that obtained by using TiO₂ under UV light (Table 2).

Table 2: Summary of the results obtained in the photocatalytic tests by using the PMR with TiO₂ and Pd/TiO₂ under UV and visible light (recirculating flow rate = 166 mL min⁻¹, T = 32 °C, 7 hours).

Catalyst	Light	Produced phenylethanol (μmol)	Productivity (mg g ⁻¹ h ⁻¹)	Extraction (%)
Pd/TiO ₂	VIS (λ >400nm)	1370.9	22.0	39.7%
TiO ₂	VIS (λ >400nm)	ND	ND	ND
TiO ₂	UV	276.2	4.44	21.9%

*ND: not detectable

The results of the present study, using Pd/TiO₂ as photocatalyst under visible light in PMRs, water as solvent and formic acid as sacrificial reagent, gave interesting perspectives for application purposes representing a green system for the reduction of acetophenone.

References

- [1] S. Kohtani, E. Yoshioka, K. Saito, A. Kudo, H. Miyab, *Catalysis Communications*, 11, 1049-1053, (2010).
- [2] X. Ke, X. Zhang, J. Zhao, S. Sarina, J. Barry, H. Zhu, *Green Chemistry*, 15, 236-244, (2013).
- [3] R. Molinari, P. Argurio, C. Lavorato, *Current Organic Chemistry*, 17, 2516-2537, (2013).

Sviluppo di metodi chimici per la riduzione del contenuto di piombo in matrici vetrose

Luisa Barbieri¹, Elena Bursi¹, Anna Corradi¹, Isabella Lancellotti¹, Chiara Ponzoni¹, Ivano Vassura²

¹*Department of Engineering "Enzo Ferrari", University of Modena and Reggio Emilia, 41125 Modena, Italy*

²*Department of Industrial Chemistry "Toso Montanari", University of Bologna, 40136 Bologna, Italy
Email: luisa.barbieri@unimore.it*

ABSTRACT

Nello studio qui presentato è stata presa in considerazione una tipologia di vetro proveniente dalla filiera dei Rifiuti da Apparecchiature Elettriche ed Elettroniche (RAEE) contenente un'elevata concentrazione di piombo, espressa come PbO, oscillante tra il 12 e il 25%. Sebbene la matrice vetrosa, in senso lato, sia nota per le sue proprietà inertizzanti, e per questo motivo sia normalmente utilizzata per inglobare alcune tipologie di rifiuti pericolosi tra cui quelli radioattivi, è stato sperimentalmente verificato come il vetro proveniente da questa filiera non possa essere propriamente ritenuto una matrice inerte. Il piombo contenuto negli strati più superficiali può infatti essere soggetto a processi di lisciviazione da parte di agenti esterni, per questo motivo lo sviluppo di una procedura chimica idonea ad abbassare il contenuto di piombo superficiale di tale vetro riducendone l'impatto ambientale e consentendone l'eventuale recupero o lo smaltimento come rifiuto non pericoloso è stato oggetto del presente lavoro. Al fine di mettere a punto un processo estrattivo efficace e a basso impatto ambientale per quanto concerne sia la procedura seguita (temperatura, tempi, cicli) che i reattivi/solventi impiegati, è stato svolto un primo screening confrontando chelanti caratterizzati da gruppi funzionali diversi quali il gruppo fosfonato (acido etidronico (HEDP), acido amino trimetilen fosfonico (ATMP) e acido etilendiammino tetrametilen fosfonico (EDTMP)) e il gruppo carbossilato (acido etilendiammino tetracetico (EDTA), acido nitrilotriacetico (NTA) e acido citrico) in differenti condizioni reattive: temperatura (amb, 80°C); pre-trattamenti in acidi; pH (pH=4; pH=10 in soluzioni tampone); concentrazione delle soluzioni di chelanti. Quindi, individuati i migliori agenti chelanti (ATMP, NTA) e le migliori condizioni estrattive (T=80°C, t=1h, pH=10) sono state messe a punto tecniche analitiche per la quantificazione sia del piombo totale prima e dopo trattamento che del piombo lisciviabile prima e dopo trattamento a pH controllato. Ciò ha permesso di compiere diverse valutazioni: i) sull'efficacia estrattiva del processo; ii) sul limite massimo di complessazione delle soluzioni dei due agenti chelanti; iii) sulla cinetica di reazione dei complessanti; iv) sui diversi cicli di vita della soluzioni estraenti; v) sull'efficacia delle soluzioni rigenerate per precipitazione del piombo estratto.

Keywords: agenti chelanti, vetri piombici, metodi estrattivi.

ToF-SIMS study of Polydimethylsiloxane (PDMS) Contamination in Microcontact Printing

Francesco Basoli¹, Luca Tortora^{2,3}, Marco Urbini^{2,3}, Sara M. Giannitelli⁴, Marcella Trombetta⁴, Silvia Licoccia¹ and Alberto Rainer⁴

¹ Department of Chemical Science and Technology, University of Rome "Tor Vergata", via della Ricerca Scientifica 1, 00133, Rome, Italy.

² Industrial Engineering Department, University of Rome "Tor Vergata", Via del Politecnico 1, 00133 Rome, Italy

³ Surface Analysis Laboratory, Department of Mathematics and Physics "E. Amaldi", University of Rome "Roma Tre", Via della Vasca Navale 84, 00146 Rome, Italy

⁴ Tissue Engineering Laboratory, CIR–Center for Integrated Research, Università Campus Bio-Medico di Roma, via Álvaro del Portillo 21, Rome, Italy

ABSTRACT

Time of Flight Secondary Ion Mass Spectrometry (ToF-SIMS) was successfully applied to the characterization of polydimethylsiloxane (PDMS) contamination on micro-contact printed patterns.

Keywords: Micro-contact printing, PDMS, ToF-SIMS

PDMS is the most widely used polymer to produce micro-contact printing (μ CP) stamps with pattern features down to the sub-micrometer length scale, also thanks to its flexibility, transparency, and chemical inertness. On the other hand, PDMS-based μ CP is affected by contaminations due to low-molecular-weight siloxane fragments released by the stamp onto the surface of the printed substrate.

In this work, we investigated the correlation between processing parameters and the resulting contamination of microcontact-printed substrates. Poly-l-lysine patterns onto cell-culture polystyrene (PS) plates were chosen as a reference system in virtue of their potential application in cell biology to direct cell adhesion and proliferation. Process parameters such as applied pressure, contact time, surface treatments and different PDMS curing conditions have been taken into account. In particular, contact pressure was controlled by a custom designed μ CP set-up equipped with a 10 N load cell. The obtained patterns were evaluated by fluorescence microscopy (using TRITC-labeled poly-l-lysine) and surface-sensitive ToF-SIMS.

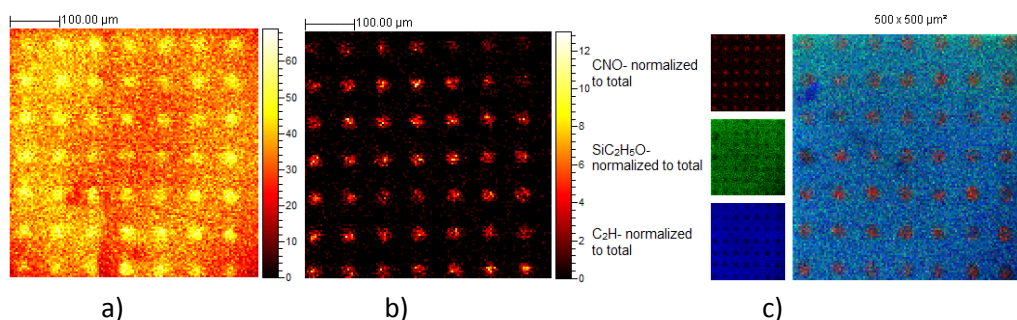

Figure 1: a-b) Positive ion ToF-SIMS images for fragments characteristic of PDMS ($73\text{ m/z SiC}_3\text{H}_9^+$) and poly-l-lysine ($84\text{ m/z C}_5\text{H}_{10}\text{N}^+$); c) RGB Overlay of the printed substrate (Red peptide backbone CNO^- , Green PDMS $\text{SiC}_2\text{H}_5\text{O}^-$, Blue substrate C_2H^-);

References

- [1] R. B. A. Sharpe, D. Burdinski, C. van der Marel, J. A. J. Jansen, J. Huskens, H. J. W. Zandvliet, D. N. Reinhoudt, B. Poelsema, *Langmuir*, 22, 2006, 5945-5951.
- [2] C. Thibault, C. S everac, A. Mingotaud, C. Vieu, M. Mauzac, *Langmuir*, 23, 2007, 10706-10714.
- [3] M. Dubey, K. Emoto, H. Takahashi, D. G. Castner, D. W. Grainger, *Advanced Functional Material*, 19, 2009, 3046-3055.

Dumbbell-shaped Polyhedral Oligomeric Silsesquioxanes (POSSs)/ Polystyrene (PS) nanocomposites: the influence of the bridge rigidity on the resistance to thermal degradation

Ignazio Blanco, Francesco A Bottino, Gianluca Cicala, Alberta Latteri

¹Department of Industrial Engineering, University of Catania, Viale A. Doria 6, 95125 Catania, Italy

Email: iblanco@dii.unict.it

ABSTRACT

A comparative study concerning the resistance to the thermal degradation of Polystyrene (PS) based nanocomposites, loaded with five novel aromatic dumbbell-shaped POSSs was carried out in dynamic heating conditions. The fillers were formed by two identical silicon cages $R_7(\text{SiO}_{1.5})_8$ (R = isobutyl) linked to several aromatic bridges (Ar, Ar-Ar, Ar-O-Ar, Ar-S-Ar and Ar-SO₂-Ar) where Ar = p-C₆H₄.

Keywords: Dumbbell-Shaped POSS, Polystyrene, nanocomposites, thermal stability

Polyhedral oligomeric silsesquioxanes (POSSs) are hybrid inorganic/organic compounds of general formula $(\text{RSiO}_{1.5})_n$, where R = H or organic substituents directly linked to silicon cage and n = 6, 8, 10 or 12. They have considerable importance owing to their excellent thermal, mechanical, optical and electrical properties due to both their nano sized and cubic structure and inorganic cage.¹ The increasing importance of POSSs is also due to their employment as fillers in the production of polymer nanocomposites. The research in this field has been directed towards the synthesis of new POSSs showing good compatibility with polymers and, at the same time, high thermal stability, through the balance of selected aliphatic and aromatic groups linked to silicon cage. Our group has in progress a wide research on the synthesis and characterization of new thermally stable POSSs to be used as fillers for PS based nanocomposites.²⁻⁵ Recently we synthesized two series of dumbbell-shaped POSSs (the first one with aliphatic bridges and the second one with aromatic bridges) and assessed their resistance to thermal degradation.^{6,7} The results we obtained with both these series of compounds indicated averagely higher thermal stability than un-bridged POSSs, in agreement with the few data reported in literature.⁸ We thus prepared the corresponding aliphatic bridged POSS/PS nanocomposites and studied their thermal degradation in both inert and oxidative atmospheres.⁹ Since the aromatic POSSs we synthesized⁷ exhibited better resistance to thermal degradation than the aliphatic ones,⁶ on continuing our research in this field, we report here the results concerned the thermal and thermooxidative degradations of POSS/PS nanocomposites loaded with the same aromatic bridged POSS⁷ aiming to obtain more thermally stable compounds. The studied systems were the following:

- 1 T-Ar-T/PS
- 2 T-Ar-Ar-T/PS
- 3 T-Ar-O-Ar-T/PS
- 4 T-Ar-S-Ar-T/PS
- 5 T-Ar-SO₂-Ar-T/PS

where T = $R_7(\text{SiO}_{1.5})_8$ and R = isobutyl; Ar = p-C₆H₄.

Analogously to our preceding experiments, nanocomposites were prepared by in situ polymerization of styrene, in the presence of the selected 5% w/w of appropriate aromatic bridged POSSs. The obtained compounds were characterized by ¹H NMR spectroscopy to verify the actual filler content. Also, glass transition temperature (T_g) was determined by Differential Scanning Calorimetry (DSC). Thermogravimetric (TG) and Differential Thermogravimetric (DTG) analysis, in both flowing nitrogen

and static air atmosphere, were finally carried out to study the thermal behaviour of our nanocomposites and to have information on the resistance to thermal and thermooxidative degradation of various samples.

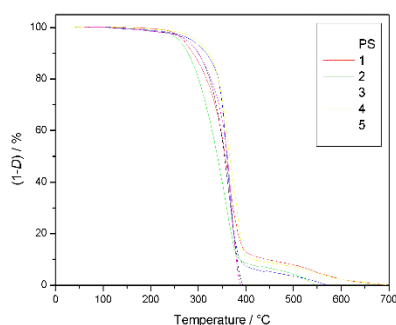

Figure 1: TG curves, Under nitrogen flow of PS and various nanocomposites.

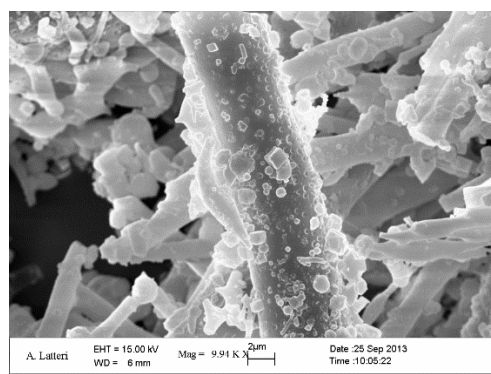

Figure 2: SEM image of sample 5.

As shown in Fig. 1, neat PS degraded completely under 400 °C, in a sharp single stage, as well as compound 5. Differently, for all 1 - 4 nanocomposites, a sharp degradation stage was observed, immediately followed, near 400 °C, by another one at low degradation rate with complete mass loss within 550 °C in static air and 700 °C in flowing nitrogen. The $T_{5\%}$ values for all studied compounds in oxidative atmosphere was lower than that in nitrogen, thus clearly indicating that oxygen plays a fundamental role in the oxidative degradation process, but the same trend was found in both used environments. A worse overall comprehensive thermal behaviour of these nanocomposites was observed in respect to nanocomposites filled with aliphatic dumbbell shaped bridged POSSs. This behaviour could be due, in our opinion, to the structures of the aromatic POSSs used for their preparation if compared with those of the aliphatic POSSs present in the nanocomposites previously investigated. Moreover, since rigid and symmetric structures facilitate POSS auto-aggregation phenomena,⁵ the presence in aliphatic POSSs of jointed chains allows to silicon cages a sufficiently free movement, which increases as a function of carbon atoms number in the bridge.⁹ This condition enhances the compatibility and miscibility of filler and polymer, and leads to the improvement of nanocomposites thermal properties. The same possibility is permitted only to not large degree to aromatic bridges, because they are spatially blocked owing to the high percentage of double bond in the links adjacent on the phenylene groups. This interpretation is supported by the Percentage Rigid Chain Length (PRCL) theory by Carlier,¹⁰ and by the SEM investigation that confirm POSSs auto-aggregation phenomena in the studied nanocomposites (Fig. 2).

References

- [1] D.B. Cordes, P.D. Lickiss, F. Rataboul, *Chem Rev*, 110, 2081-2173, (2010).
- [2] I. Blanco, L. Abate, F.A. Bottino, P. Bottino, M.A. Chiacchio, *J Therm Anal Calorim*, 107, 1083-91, (2012).
- [3] I. Blanco, L. Abate, F.A. Bottino, P. Bottino, *J Therm Anal Calorim*, 108, 807-15, (2012).
- [4] I. Blanco, L. Abate, F.A. Bottino, P. Bottino, *Polym Degrad Stab*, 97, 849-55, (2012).
- [5] I. Blanco, F.A. Bottino, P. Bottino, *Polym Compos*, 33, 1903-10, (2012).
- [6] I. Blanco, L. Abate, F.A. Bottino, *J Therm Anal Calorim*, 116, 5-13, (2013).
- [7] I. Blanco, L. Abate, F.A. Bottino, P. Bottino, *J Therm Anal Calorim*, 117, 243-50, (2014).
- [8] S. Spoljaric, A. Genovese, R.A. Shanks, *J Appl Polym Sci*, 123, 585-600, (2012).
- [9] I. Blanco, L. Abate, F.A. Bottino, P. Bottino, *Polym Degrad Stab*, 102, 132-7, (2014).
- [10] V. Carlier, J. Devaux, R. Lepas, P.T. McGrail, *Macromolecules*, 25, 6646-50, (1992).

Microwave assisted pyrolysis of sewage sludge: production of oils and energetic balance

A. Buttafava¹, A. Zeffiro¹, D. Dondi¹, P. Arcioni², D. Canova¹

¹ Department of Chemistry, University of Pavia, Viale Taramelli, 12 - 27100 - Pavia, Italy.

² Department of Industrial Engineering and Information, University of Pavia, Via Ferrata, 1 - 27100 - Pavia, Italy.

Email: Armando.buttafava@unipv.it

ABSTRACT

Single mode microwave oven was used to produce oils from sewage sludge. Oils were characterized by GC-MS analysis, elemental analysis and heating value. A balance between emitted microwave energy and (ideal) energy recovery from the combustion of oils was made in function of temperature and quantity of microwave absorbers (char derived from previous pyrolysis).

Keywords: Single mode microwave oven, sewage sludge

The disposal of sewage sludge produced by wastewater treatment plants is a matter of great concern. The most common alternatives of treatment and/or disposal of sewage sludge are sludge landfill, cropland application, incineration and ocean dumping, none of which are exempt of drawbacks. Pyrolysis of the production of bio oils could be a valid alternative. In this study we have used a single mode microwave oven (fig. 1) to produce pyrolytic oils from dried sewage sludges. By using the single wave microwave oven it's possible to tune and thus to heat also dried material, since a especially designed microwave resonator was used. In this way it's possible to measure the energy absorbed by the sample.

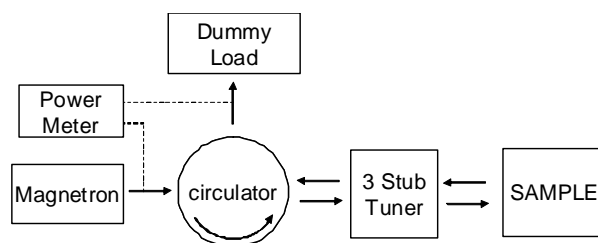

Fig. 1. Schematic design of single mode microwave oven

The pyrolysis was performed in the temperature range 200-800 °C in order to find the best conditions in terms of oil yields and energetic consumption.

A pyrolysis temperature of 300 °C was found to be the best compromise between oil yield and energy spent for the process. At this temperature the effect of microwave absorbers, viz. carbon residues obtained from previous pyrolysis, was investigated.

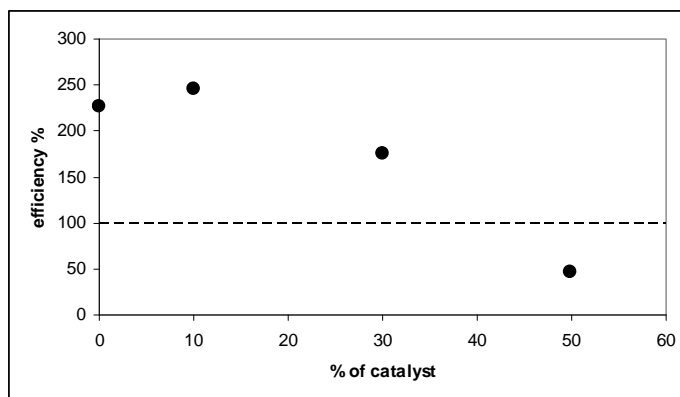

Fig.2. Energetic efficiency, i.e. absorbed microwave energy/energy derived from oil combustion, vs. % of catalyst used.

The energetic balance, i.e. the ratio between absorbed microwave energy and (theoretical) thermal energy derived from combustion of formed oils, shows that in most cases the thermal energy is higher than the energy used for the process (fig.2). In this balance the energy derived from combustion of gases was neglected. Single mode microwave oven gave an high efficiency even if no microwave absorbers were used. From a practical point of view the use of a small amount of microwave absorbers (10%) could be instead interesting since the tuning procedure is easier. Compared with conventional heating, microwave heating saves considerable time and energy for a similar degree of pyrolysis. The microwave treatment of sewage sludge makes it possible to achieve a volume reduction of wastes and providing a source of fuel gases and liquids.

References

- [1] Y. Yang, J.G. Brammer, M. Ouali, J. Samanya, A. Hornung, H.M. Xu, Y. Li
Characterisation of waste derived intermediate pyrolysis oils for use as diesel engine fuels
Fuel (2013) 247-257.

Film ibridi organico-inorganici preparati via sol-gel dip coating per il potenziamento delle proprietà biologiche di impianti in lega di Titanio grado 4

Michelina Catauro, Ferdinando Papale, Flavia Bollino

Department of Industrial and Information Engineering, Second University of Naples, Via Roma, 81031 Aversa (CE), Italy

Email: michelina.catauro@unina2.it

ABSTRACT

I complessi fenomeni che accompagnano il processo di integrazione di un biomateriale sono strettamente correlati con le caratteristiche superficiali del sistema interagente a causa dell'estrema reattività dello strato superficiale. Nel tentativo di migliorare l'interazione materiale-tessuto e favorirne l'integrazione assumono notevole importanza i trattamenti di modifica superficiale. Nel presente lavoro impianti di Titanio grado 4 (Ti gr. 4) sono stati rivestiti mediante dip coating con materiali ibridi organico-inorganici sintetizzati utilizzando il metodo sol-gel per potenziare le proprietà biologiche del metallo. I materiali e i film sono stati, poi, caratterizzati dal punto di vista chimico e microstrutturale impiegando numerose tecniche strumentali (FTIR, NMR, AFM, SEM/EDS). Sono, inoltre, state valutate le proprietà biologiche mediante test in vitro mirati a confermare l'effettivo potenziamento della bioattività e della biocompatibilità degli impianti rivestiti.

Keywords: Sol-gel, Ibridi organico-inorganici, dip coating, bioattività, biocompatibilità

Introduzione

La superficie dei biomateriali svolge un ruolo essenziale nel definire le caratteristiche e le prestazioni globali dello stesso e può essere modificata allo scopo di migliorarne le complessive prestazioni. L'utilizzo pratico di qualsiasi biomateriale comporta, infatti, la formazione di un'interfaccia tra questo e il sistema biologico in corrispondenza della quale avvengono le interazioni con i tessuti circostanti. Può, dunque, risultare vantaggioso modificare la superficie del biomateriale per favorirne il processo di integrazione, migliorarne la biocompatibilità e le complessive prestazioni. In tal modo è possibile ottenere un nuovo materiale che, pur possedendo diverse caratteristiche superficiali, conservi le medesime proprietà meccaniche e fisiche del materiale di partenza[1]. La modifica di superfici utilizzando la tecnica del dip coating permette il facile rivestimento di substrati di diversa natura e forma con materiali ottenuti con il processo sol-gel, un metodo per la produzione di vetri e ceramici a basse temperature [2]. In tale studio ibridi ZrO₂/PCL sono stati sintetizzati via sol-gel ed utilizzati per rivestire, mediante dip coating, substrati di Ti gr. 4 per potenziarne le proprietà biologiche legate alla superficie.

Materiali e Metodi

I materiali ibridi ZrO₂/PCL sono stati sintetizzati utilizzando la tecnica sol-gel. Ad una soluzione idroalcolica di un precursore metallorganico, il propossido di zirconio Zr(OC₃H₇)₄, è stato aggiunto il

policaprolattone (PCL), previamente solubilizzato in cloroformio, nelle percentuali dello 0, 6, 12, 24 e 50 %. Per regolare l'elevata attività idrolitica dell'alcolossido è stato introdotto l'acetilacetone ($\text{CH}_3\text{COCH}_2\text{COCH}_3$) come inibitore. Il sol è stato utilizzato per rivestire impianti di Ti gr. 4 (passivati in HNO_3), utilizzando un KSV LM dip coater. Lo studio delle interazioni presenti tra la fase organica e quella inorganica all'interno dell'ibrido è stato effettuato utilizzando uno spettrometro FTIR Prestige 21 e uno spettrometro NMR AMX400WB (Bruker) equipaggiato con sonda MAS da 4 mm. L'analisi microstrutturale dei materiali e dei film è stata effettuata utilizzando un microscopio a forza atomica AFM Perception e un microscopio a scansione elettronica SEM FEI Quanta 200 munito di EDAX per eseguire la microanalisi dei campioni. Infine, per confermare l'effettivo potenziamento delle proprietà biologiche del substrato, sono stati eseguiti test di bioattività e biocompatibilità sui supporti rivestiti. La bioattività è stata valutata immergendo i campioni in una soluzione simulante il plasma sanguigno (SBF o Simulated Body Fluid) tenuta a 37°C . A diversi intervalli di tempo, i campioni, dopo essere stati asciugati, sono stati osservati al SEM per valutare l'abilità a promuovere la formazione di uno strato di idrossiapatite sulla loro superficie. Lo studio della biocompatibilità è stato eseguito effettuando il test di citotossicità o saggio WST-8, un test colorimetrico di tipo indiretto che fornisce informazioni sulla vitalità delle cellule attraverso la valutazione della loro attività metabolica, inibita dalla presenza di agenti tossici.

Risultati e discussione

Dall'analisi degli spettri FTIR (Figura 1) dei materiali ibridi si osserva la presenza dei picchi di assorbimento caratteristici del PCL, a 2928 e a 2840 cm^{-1} (stretching simmetrico dei gruppi $-\text{CH}_2-$) e a 1730 cm^{-1} (stretching del gruppo carbonile $-\text{C}=\text{O}$), i quali aumentano di intensità all'aumentare della quantità di polimero introdotta nella sintesi. La presenza della banda slargata nella zona tra $3200-3600\text{ cm}^{-1}$, caratteristica dei gruppi O-H, suggerisce la formazione di ponti a idrogeno tra il carbonile del PCL e gli OH del network inorganico. Tale ipotesi è confermata dallo shift dei picchi di risonanza del PCL puro che si osserva negli spettri ^{13}C MAS-NMR dei materiali ibridi [3, 4].



Figura 1 Spettri FTIR di: (a) ZrO_2 ; (b) $\text{ZrO}_2 + \text{PCL}6\%$; (c) $\text{ZrO}_2 + \text{PCL}12\%$; (d) $\text{ZrO}_2 + \text{PCL}24\%$; (e) $\text{ZrO}_2 + \text{PCL}50\%$.

Le topografie AFM dei materiali ibridi e dei film mostrano che la distanza media tra i domini è di circa 20 nm , a conferma che i materiali sintetizzati sono ibridi nanocompositi [5]. Le osservazioni al SEM hanno rilevato che i film costituiti da sola zirconia sono molto fratturati (Figura 2a) e che la

presenza di microcricche diminuisce all'aumentare della percentuale di polimero inglobata nel film, fino a scomparire quando è incorporato il 50% di PCL (Figura 2b). Tale risultato suggerisce che il polimero agisce da plasticizzante aumentando l'elasticità del film, ipotesi supportata dalla letteratura [5].

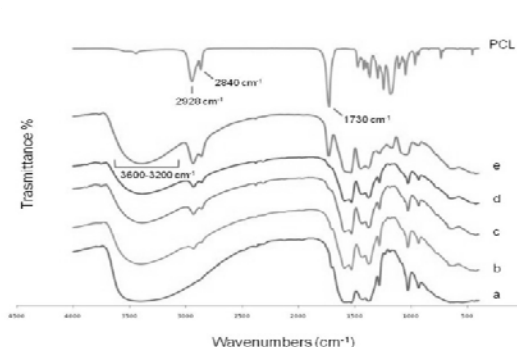

Figura 2 Micrografie SEM dei substrati in Ti gr. 4 rivestiti con (a) ZrO₂ e (b) ZrO₂ + PCL 50% e (c) dopo 21 gg in SBF

Nelle immagini SEM, acquisite dopo l'immersione dei sistemi rivestiti in SBF (Figura 2c), è evidente la presenza delle formazioni globulari tipiche dell'idrossiapatite sulla superficie dei materiali. Ciò si traduce come la capacità, di tali sistemi, di osteointegrarsi una volta impiantati in vivo. Inoltre, il saggio colorimetrico del WST-8 dimostra che i film di rivestimento rendono i supporti di Ti gr. 4 maggiormente biocompatibili [3].

Conclusioni

La tecnica sol-gel dip coating risulta un metodo economico, versatile e molto promettente per la modifica di superfici. Film organico-inorganici nanocompositi appaiono molto bioattivi e biocompatibili e consentono di potenziare notevolmente le proprietà biologiche degli impianti di Ti gr. 4.

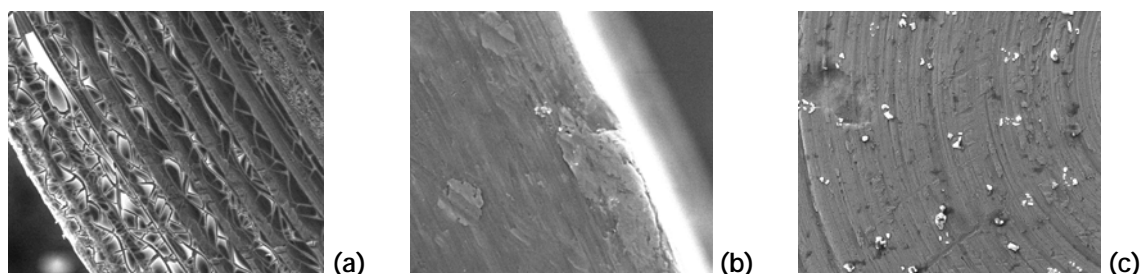
Riferimenti

- [1] C. Di Bello, *Biomateriali: introduzione allo studio dei materiali per uso biomedico*, Patron Editore, (2004).
- [2] C. Brinker, G. Scherer, *Sol-Gel Science: the Physics and Chemistry of Sol-Gel processing*, Academic press, (1989).
- [3] M. Catauro, F. Bollino, F. Papale, *Journal of Biomedical Materials Research - Part A*, 102, 392-99, (2014).
- [4] M. Catauro, D. Verardi, D. Melisi, F. Belotti, P. Mustarelli, *Journal of Applied Biomaterials and Biomechanics*, 8, 42-51, (2010).
- [5] M. Catauro, F. Bollino, P. Veronesi, G. Lamanna, *Materials Science and Engineering C*, 39, 344-51, (2014).

Investigation on the Proton Exchange Equilibrium between Bases and BMImBF₄: an Electrochemical Procedure to Quantify the Amount of Carbene

Isabella Chiarotto¹, Marta Feroci¹, Gianpiero Forte¹, Monica Orsini², Stefano Vecchio Cipriotti¹

¹Dept. of SBAI, Sapienza University of Rome, via Castro Laurenziano, 7, 00161 Roma, Italy

²Dept of Elettronica Applicata, University of RomaTre, via Vasca Navale, 84, 00146 Roma, Italy

Email: isabella.chiarotto@uniroma1.it

ABSTRACT

Cyclic voltammetry enables to verify if a proton exchange reaction occurs between a base and BMImBF₄, yielding NHC. The proton exchange was verified carrying out the NHC-catalyzed oxidation of aldehydes to esters.

Keywords: Cyclic Voltammetry, BMImBF₄, N-Heterocyclic carbene

The actual ability of a base to yield the N-heterocyclic carbene (NHC) from the ionic liquid 1-butyl-3-methylimidazolium tetrafluoroborate (BMImBF₄) was investigated by an electrochemical procedure. Accordingly, the proton exchange equilibrium between different bases (DBU, *i*Pr₅-guanidine, Cs₂CO₃, 2,4,6-collidine, TEA) and the BMIm⁺ cation was studied in BMImBF₄ as solvent (Scheme 1). The concentration of NHC, generated by the addition of the bases to BMImBF₄, is derivable from the anodic peak current (due to the NHC oxidation) of the recorded voltammograms (Figure 1). [1]

The electrochemical procedure allowed to evaluate the possible utilization of the solutions of bases in BMImBF₄ as media able to induce known NHC-catalyzed and base promoted syntheses. NHC-Catalyzed oxidation of aldehydes to esters [2] and base promoted cyclization of bromoamides to β-lactams were taken as model reactions. All the results from the syntheses are in line with the expectations from the electrochemical measurements.

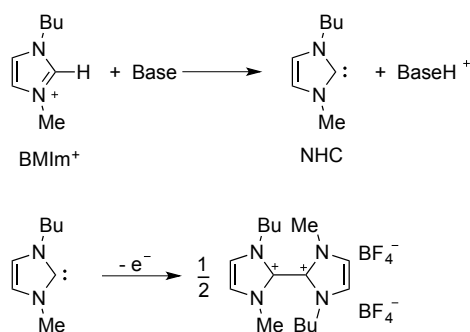

Scheme 1. Equilibrium of proton exchange and anodic oxidation of NHC.

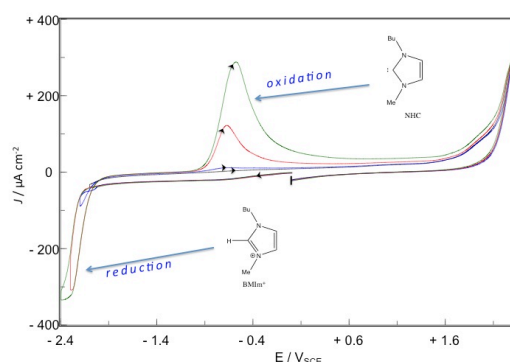

Figure 1: Voltammetric curves of BMImBF₄.

References

- [1] M. Feroci, I. Chiarotto, G. Forte, S. Vecchio Cipriotti, A. Inesi, *ChemElectroChem*, in press, (2014) DOI: 10.1002/celc.201300269
- [2] I. Chiarotto, M. Feroci, G. Sotgiu, A. Inesi *Tetrahedron* 69, 8088-8095, (2013).

Solvent polarity effects on the photophysical properties of some ionic NLO chromophores

Giuseppe Consiglio,¹ Salvatore Failla,¹ Cosimo G. Fortuna,² Anna Spalletti³

¹Dipartimento di Ingegneria Industriale, Università di Catania, 95125 Catania, Italy

²Dipartimento di Scienze Chimiche, Università di Catania, 95125 Catania, Italy

³Dipartimento di Chimica, Università di Perugia, 06123 Perugia, Italy

Email: gconsiglio@dii.unict.it

ABSTRACT

Solvent polarity effects on the photophysical properties of some stilbazolium iodides have been investigated by stationary and transient absorption techniques to reach a general picture of the relaxation pathways and get information on the hyperpolarizability through the study of their solvatochromism. The important role of the photoinduced intramolecular charge transfer has been evidenced.

Keywords: NLO, push-pull, negative solvatochromism.

In the framework of our long-term project on the internal rotation around double and single bonds, we have been recently concerned with the study of quaternized azastilbenes^{1,2} since methylpyridinium and -quinolinium salts can be of interest for potential applications in the medical fields, due to their ability to form complexes with DNA, and in optoelectronics/ photonics as NLO materials.

The positive solvatochromism of push-pull systems is well documented in the literature and also studied in our laboratory for a series of compounds.³⁻⁴ On the other hand, the negative solvatochromism, where the molecular dipole moment is expected to decrease under excitation, is comparatively less studied.

A significant blue shift of the absorption spectrum was observed for the studied salts in polar solvents while the emission remains in the same spectral region. A peculiar fluorosolvatochromism observed for a dimethylamino-derivative was explained by the presence of a dual emission from the locally excited singlet state (1LE*), reached by absorption, and the charge transfer singlet state (1CT*), formed by the intramolecular CT (ICT) process.

Results obtained by fast (ns) and ultrafast (fs) absorption spectroscopies evidenced the presence of intramolecular charge transfer processes in the singlet and triplet manifold, controlled by the solvent polarity, and allowed the deactivation mechanism to be highlighted.

A detailed study on the solvatochromism allowed to evaluate the change of the dipole moment in the excited state and the hyperpolarizability of these compounds. The high value of the latter indicates their potential application as NLO materials.

References

- [1] E. Marri, U. Mazzucato, C. G. Fortuna, G. Musumarra, A. Spalletti, *J. Photochem. Photobiol. A: Chem.*, 2006, 179, 314.
- [2] A. Mazzoli, B. Carlotti, C. Bonaccorso, C.G. Fortuna, U. Mazzucato, G. Miolo, A. Spalletti, *Photochem. Photobiol. Sci.*, 2011, 10, 1830.
- [3] S. Ciorba, G. Galiazzo, U. Mazzucato, A. Spalletti, *J. Phys. Chem. A*, 2010, 114, 10761.
- [4] I. Baraldi, E. Benassi, S. Ciorba, M. Šindler-Kulyk, I. Škorić, A. Spalletti, *Chem. Phys.*, 2009, 361, 61.

An effective method for the removal of metal ions from wastewater based on natural clay and wood sawdust sorbents

*Roberta Del Sole*¹, *Alena A. Fogel*², *Lucia Mergola*¹, *Maria Pia Di Bello*¹, *Giuseppe Vasapollo*¹, *Vladimir A. Somin*², *Larisa F. Komarova*²

¹Department of Engineering for Innovation, University of Salento, Via Monteroni, 73100 Lecce, Italy

² I.I. Polzunov Altai State Technical University, Barnaul, Russia

Email: mariapia.dibello@unisalento.it

ABSTRACT

Keywords: heavy metal removal, copper, nickel, bentonitic clay, wood sawdust.

The naturally available bentonitic clay has been considered an ideal material for heavy metal adsorption, mainly because of the overall low cost, together with its high sorption properties and an almost unlimited availability. Further advantages of using clay as an adsorbent consist of an excellent physical and chemical stability, a great specific surface area, and several other structural and surface properties of bentonite [1].

On the other side, it is worth mentioning that also wood sawdust has been exploited in environmental sorption, especially in effluents, of heavy metals such as copper and nickel [2]. Similarly to bentonitic clay, in fact, also the wood sawdust is a natural material widely available in nature at low cost. However, a direct application of wood sawdust as sorbent is still limited due to its low sorption characteristics.

In the present work, we aim to combine the use of both wood sawdust and bentonite, in order to achieve an effective sorption material having high mechanical stability. In particular, different kind of wood, as well as bentonite clays and sawdust modification methods have been used for preparing the sorbents. These sorbents were characterized by means of X-ray diffraction (XRD), Fourier transform infrared spectroscopy (FTIR) and scanning electron microscope (SEM) methods (Figure 1). The prepared materials were used for the removal of copper and nickel ions from water. The sorption capacity of sorbents in static conditions and kinetics has been studied in water solution. The adsorption process was well described by the pseudo-second-order kinetics model. The results have shown that the adsorption capacity depends on the kind of wood. These materials have shown a good adsorption characteristic that make them good candidates as inexpensive and effective sorbents for heavy metals removal.

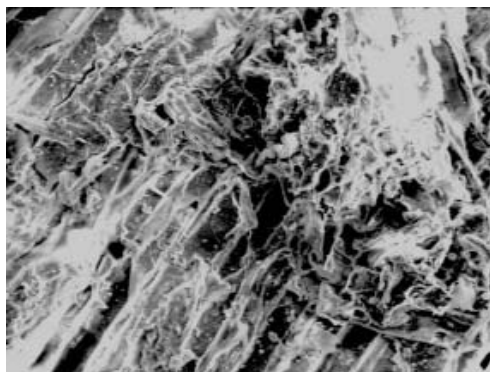

Figure 1: SEM of sawdust-based bentonite clay sorbent (500x)

References

- [1] B.I. Olu-Owolabi, I.E. Unuabonah, *Journal of Hazardous Materials*, 184, 731-738A, (2010).
- [2] M. Šćiban, B. Radetić, Ž. Kevrešan, M. Klačnja, *Bioresource Technology*, 98, 402-409, (2007).

Nanocomposite Proton Exchange Membranes with Low Methanol Permeability for Direct Methanol Fuel Cells

Alessandra D'Epifanio, Catia de Bonis, Barbara Mecheri, Isabella Nicotera, and Silvia Licoccia

Department of Chemical Science and Technology, University of Rome Tor Vergata, Via della Ricerca Scientifica, 00133 Rome, Italy

Email: alessandra.d.epifanio@uniroma2.it

ABSTRACT

During the last decades, a wide range of metallic oxides have been embedded in polymer matrices with the aim to obtain composite membranes with improved performance in direct methanol fuel cells (DMFCs), in terms of ohmic resistance reduction, higher power density delivered and lower methanol crossover. However, the presence of scarcely conductive inorganic species can entail a decrease of the overall proton conductivity of the electrolyte. The use of an organic-inorganic hybrid filler is an effective tool to minimize the proton conductivity losses induced by the introduction of inorganics in the polymeric matrix. Moreover, the uniform dispersion of filler can be favored by the enhanced interfacial compatibility with hydrophobic and hydrophilic domains of the polymer matrix [1]. In this work, the organically modified nanometric titania: $\text{TiO}_2\text{-RSO}_3\text{H}$, in which aliphatic chains bearing sulfonic acid groups are covalently bound to the oxide surface, was synthesized and used as filler in composites based on sulfonated polyetheretherketone (SPEEK) (Figure 1). The filler and membrane properties were studied by means of electrochemical impedance spectroscopy, ion exchange capacity measurements, and nuclear magnetic resonance spectroscopy. The introduction of covalently bound propylsulfonic acid groups led to an increased of ion exchange capacity and proton conductivity of the metal oxide. As a consequence, the $\text{TiO}_2\text{-RSO}_3\text{H}$ composite showed higher conductivity than SPEEK, whilst lower conductivity values was observed for the TiO_2 composite. The organic functionalization of the filler had a beneficial effect also for the reduction of methanol diffusion through the SPEEK-based composite membrane, as highlighted by the measurement of methanol self-diffusion coefficient. The 10 wt% $\text{TiO}_2\text{-RSO}_3\text{H}$ composite showed a distinctly lower methanol permeability.

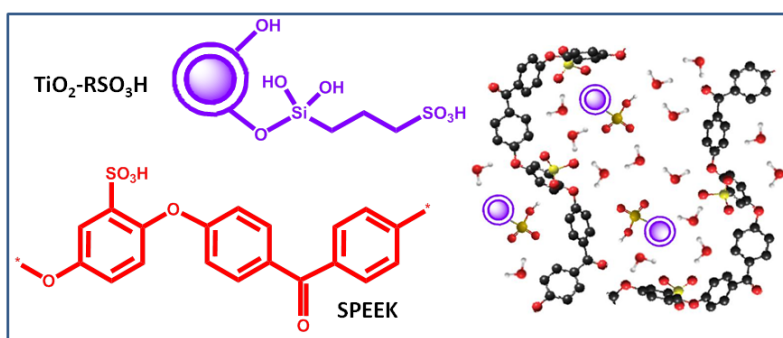

Figure 1: Chemical structure of $\text{TiO}_2\text{-RSO}_3\text{H}$ and SPEEK. Schematics of filler/polymer interaction.

References

- [1] D. Cozzi, C. de Bonis, A. D'Epifanio, B. Mecheri, A.C. Tavares, S. Licoccia, *J Power Sources*, 248, 1127-1132 (2014).

Phthalocyanines-TiO₂: a New Efficient and Tunable Catalysts for CO₂ Reduction in Water

Alberto De Riccardis¹, Giuseppe Mele¹, Lucia D'Accolti², Leonardo Palmisano³, Giuseppe Vasapollo¹

¹Dipartimento di Ingegneria dell'Innovazione, Università del Salento, Via Monteroni, 73100 Lecce

²Dipartimento di Chimica, Università degli Studi di Bari "Aldo Moro", via Orabona 4, 70126 Bari

³Dipartimento di Energia, Ingegneria dell'Informazione e Modelli Matematici, DEIM, Università di Palermo, Viale delle Scienze, Ed. 6, 90128 Palermo

Email: alberto.dericcardis@unisalento.it

ABSTRACT

Organic sensitizer loaded over TiO₂ (anatase), in particular Cu(II) tetrakis [4-(2,4-bis-(1,1-dimethylpropyl)phenoxy)]phthalocyanines was proved to be active in the photoreduction of CO₂ to formic acid (HCO₂H) in water under UV-Vis light. Because of their low environmental impact, low potential cost, and efficient power conversion, these multipurpose materials show promise in the setup of sustainable methods for CO₂ valorization

Keywords: CO₂ reduction, photocatalysis, phthalocyanines, porphyrins

The combination of TiO₂ with different kinds of sensitizers allowed to obtain extremely versatile composite sensitized materials having oxidizing properties suitable to photodegrade organic pollutants in water [1]. More recently, the reductive properties to photo-reduce CO₂ in aqueous medium have been investigated [2].

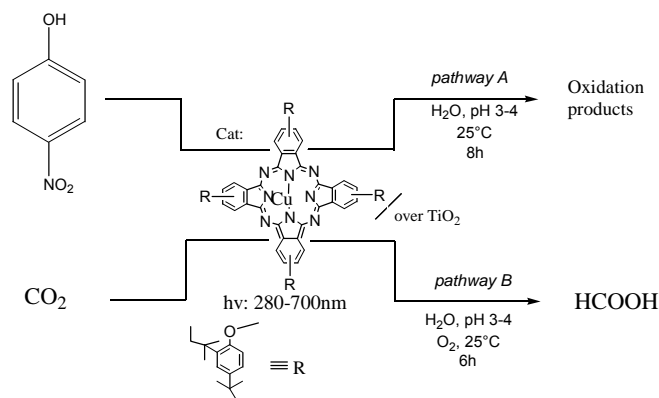

In this work, composite materials prepared by loading polycrystalline TiO₂ powders with lipophilic highly branched Cu(II)- and metal-free phthalocyanines or porphyrins, which have been used in the past as photocatalysts for photo degradative processes, have been successfully tested for the efficient photoreduction of carbon dioxide in aqueous suspension affording significant amounts of formic acid. The results indicated that the presence of the sensitizers is beneficial for the photoactivity, confirming the important role of Cu(II) co-ordinated in the middle of the macrocycles. A comparison between Cu(II) phthalocyanines and Cu(II) porphyrins indicated that the Cu(II)- phthalocyanine sensitizer was more efficient in the photoreduction of CO₂ to formic acid probably due to its favorable reduction potential.

We have employed the highly hydrophobic Cu(II)tetrakis [4-(2,4-bis-(1,1-dimethylpropyl)phenoxy)] phthalocyanine (CuPc) in order to avoid the dissolution on sensitizer in water .

Typically, the loaded samples used as photocatalysts for the photoreactivity experiments were prepared by impregnating TiO₂ (Tioxide, Huntsman anatase phase) with various amounts of CuPc (4,5, 6.65 and 8,5 μmol/g TiO₂). The sensitizers were dissolved in 5 mL of CH₂Cl₂ and 500 mg of finely ground TiO₂ was added to this solution. The mixture was stirred for 6 h and the solvent was removed under vacuum. The reaction conditions are mild: 0.05 g of catalyst in water at pH 3 at room temperature under UV-Vis light (the experimental set-up is shown in Fig. 1).

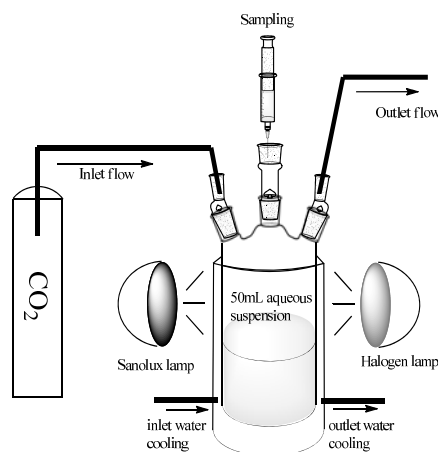

Figure 1: Experimental set-up

TiO₂ (anatase) samples impregnated with functionalized 6.65 μmol CuPc /1g TiO₂ CuPc results to be 62% more effective compared to bare TiO₂ in the production of formic acid. The maximum yield for 8 hours of reaction was 210 μmol·g·cat⁻¹

The possibility to work under similar experimental conditions (acid pH, amount of catalyst, opportune combination of irradiation sources) for the photo-oxidation and the photo-reduction reactions implies that it is possible to switch from one reaction to another by changing only the substrate and replacing O₂ with CO₂ in the photoreduction process. This new class of multipurpose materials in very mild conditions could be considered among the affordable technologies because of their relatively low potential costs and environmental impact.

References

- [1] G. Mele, R. Del Sole, G. Vasapollo, E. García-López, L. Palmisano, M. Schiavello, J. Catal. Catalysis 217 (2), 334-342, (2003).
- [2] G. Mele, C. Annese, A. De Riccardis, C. Fusco, L. Palmisano, G. Vasapollo, L. D'Accolti, Appl. Cat. A: General 481,169-172 (2014).

Synthesis and properties studies of novel photoswitchable azobenzene polymers

Maria Pia Di Bello¹, Lucia Mergola¹, Giuseppe Vasapollo¹, Roberta Del Sole¹

¹Department of Engineering for Innovation, University of Salento, Via Monteroni, 73100 Lecce, Italy

Email: roberta.delsole@unisalento.it

ABSTRACT

Keywords: imprinted polymers, azobenzenes, photoresponsive materials

Photo-irradiation is one of the most frequently adopted external stimuli for stimuli responsive materials as it is convenient to apply and easy to control.

Selective enrichment and separation of metal ions, including toxic heavy metal ions in water, low content of rare metal ions in the earth crust as well as some precious metals, is nowadays an important research field.

In the last decades several methods for metal ions enrichment and separation from water samples have been developed such as electrolysis, precipitation and ion exchange. However, traditional techniques do not perform very well on selective removal of the target metal ions. Ion imprinted polymer (IIP) is a convenient alternative technique capable to selectively recognize a target metal ion. In IIP the target specie is added during polymer preparation. After polymerization the template is removed by washing procedures leaving a highly cross-linked polymer containing well defined cavities for the template. Ion imprinted polymer able to recognize the target ion with high selectivity has been applied in solid phase extraction, sensors and membrane separations of inorganics [1].

With the incorporation of a reversibly photoswitchable chromophore, such as azobenzene derivatives (Azo), into the imprinted binding sites, photoregulated uptake of metal ion templates can be obtained. In fact, it is well known that azobenzene derivatives upon UV irradiation undergo E-Z isomerization while upon visible light irradiation, Z-E isomerization occurs [2].

In the present work, we report the design and characterization of a novel polymer based on photoswitchable azobenzene derivatives which can be employed for ion imprinted polymer systems enable to specifically uptake and release metal ions in aqueous media.

Firstly, an aqueous compatible azobenzene derivative bearing sulphonic functional group (Azo) was synthesized and successively included into a chitosan matrix. Chemical and morphological characterization of the prepared polymer has been performed through FTIR and SEM analysis. Finally UV-Visible isomerization studies and Kinetics of the photoisomerization processes are shown.

References

- [1] T.P. Rao, R. Kala, S. Daniel, *Analytica Chimica Acta*, 578, 105-116, (2006).
- [2] C. Gong, K.L. Wong, M.H.W. Lam, *Chemistry of Materials*, 20, 1353-1358, (2008).

Influence of Nylon 6,6 nanofiber mats on cure behavior and properties of CFR epoxy resin

Maria Di Filippo, Sabina Alessi, Maria Letizia Focarete, Chiara Gualandi, Roberto Palazzetti, Giuseppe Pitarresi, Andrea Zucchelli, Giuseppe Spadaro, Clelia Dispenza

¹Dipartimento di Ingegneria Chimica, Gestionale, Informatica, Meccanica (DICGIM), Università degli Studi di Palermo, Palermo, Italy

²Department of Chemistry "G. Ciamician" and National Consortium of Materials Science and Technology (INSTM, Bologna RU), University of Bologna, Bologna, Italy

³Department of Design, Manufacture and Engineering Management, University of Strathclyde, Glasgow, UK

⁴Department of Industrial Engineering (DIN) and Advanced Mechanics and Materials- Interdepartmental Center for Industrial Research (AMM ICIR), University of Bologna, Bologna, Italy

Email: clelia.dispenza@unipa.it

ABSTRACT

In this work Nylon 6,6 nanofibrous mats produced by electrospinning were used as interlayers in carbon fiber reinforced laminates. A high crosslinked epoxy resin was chosen as matrix. The effects of polymeric mats on cure behavior, thermal and delamination properties of the composite laminates were investigated.

Keywords: Epoxy resin, Composite laminates, Electrospinning

Delamination is one of the most common failure mechanisms of composite laminates subjected to impact or cycles of loading [1]. An innovative strategy to improve the delamination resistance is based on use of nanofibrous polymeric mats, produced by electrospinning [1-4]. Electrospinning is a technology which utilizes strong electric fields to produce polymer fibers with diameters ranging from tens of nanometres to several micrometers [5,6]. The aim of this work is investigate the effects of electrospun nanofibrous mats on the cure behavior and on the thermal and mechanical properties of high performance carbon fiber reinforced (CFR) epoxy resin.

Non-woven nanofibrous Nylon 6,6 mats were produced by electrospinning from a Nylon 6,6 polymer solution. The matrix system selected is a mixture of bi- and tetra-funcional epoxy monomer, and an amine curing agent. Calorimetric (DSC) and dynamic-mechanical-thermal (DMTA) analyses were carried out on the neat resin and on a mat/resin monolayer to evaluate the influence of the electrospun Nylon 6,6 nanofibres on either the curing behavior or the crosslinking of the resin. Scanning Electron Microscopy (SEM) morphologies of the monolayer were also examined to investigate the interface Nylon nanofibers/epoxy resin. Finally, the thermal and delamination behavior of carbon fiber reinforced polymer (CFRP) laminates interleaved with electrospun Nylon mats was studied. Mode I delamination tests revealed an increase of the initial fracture toughness of about 50% in the interleaved system with respect the not modified system [4].

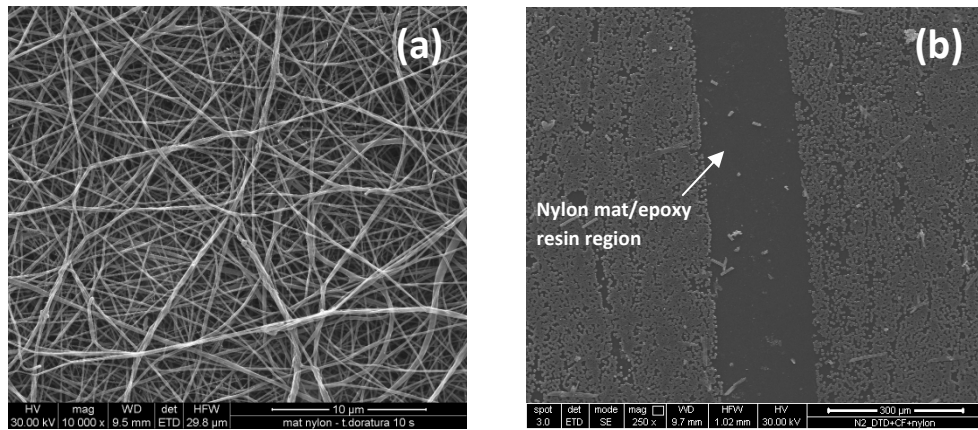

Figure 1: SEM micrograph of: a) electrospun Nylon 6,6 mat; b) carbon fibers/epoxy/Nylon mat composite transverse section

References

- [1] R. Palazzetti, A. Zucchelli, C. Gualandi, M.L. Focarete, L. Donati, G. Minak, S. Ramakrishna, *Composite Structures*, 94, 571-579, (2012).
- [2] G. Li, P. Li, C. Zhang, Y. Yu, S. Zhang, X. Jia, X. Yang, Z. Xue, S. Ryu, *Composites Science and Technology*, 68, 987-994, (2008).
- [3] Q. Chen, L. Zhang, A. Rahman, Z. Zhou, X.F. Wu, H. Fong, *Composites Part A: Applied Science and Manufacturing*, 42, 2036-2042, (2011)
- [4] S. Alessi, M. Di Filippo, C. Dispenza, M.L. Focarete, C. Gualandii, R. Palazzetti, G. Pitarresi, A. Zucchelli, *Polymer Composites*, (2014) DOI: 10.1002/pc.23035.
- [5] N. Bhardwaj, S.C. Kundu, *Biotechnology Advances*, 28, 325-347, (2010).
- [6] Z.M. Huang, Y.Z. Zhang, M. Kotaki, S. Ramakrishna, *Composites Science and Technology*, 63, 2223-2253, (2003).

Synthetic and natural polymer nanoparticles as bio-imaging and therapeutic agent vectors

Clelia Dispenza^{1,2}, Simona Todaro^{1,2}, Lorena Anna Ditta¹, Alessia Ajovalasit¹, Maria Antonietta Sabatino¹, Natascia Grimaldi¹, Giuseppe Spadaro¹

¹Dipartimento di Ingegneria Chimica, Gestionale, Informatica, Meccanica (DICGIM) Università degli Studi di Palermo, Italy;

²CNR - Istituto di Biofisica (IBF) UOS Palermo, via Ugo La Malfa 153, 90146 Palermo, Italy

email: clelia.dispenza@unipa.it

ABSTRACT

Polymer nanoparticles have been designed, synthesized and characterized as bio-imaging and therapeutic agent vectors. Two different nanomaterial platforms have been developed starting from a synthetic polymer, poly(N-vinyl pyrrolidone) (PVP), crosslinked and functionalized via e-beam irradiation, and a polysaccharide, namely xyloglucan, partially degalactosylated via an enzymatic reaction. Surface decoration, drug encapsulation and cytotoxicity evaluation have been performed.

Keywords: polymer nanoparticles, radiation chemistry, nanomedicine.

Functional polymeric nanoparticles are widely studied as drug delivery systems and/or bio-imaging agent carriers for intra-venous administration, thanks to their ability to pass through the smallest capillary vessels and to incorporate, protect and address to the target site active molecules.

Different synthetic approaches have been developed to prepare polymeric nanoparticles with tunable properties. The molecular structure of the polymer is crucial to determine their physico-chemical features and functions and both synthetic and natural polymers can be chosen as raw material candidates. Ionising irradiation can be performed to tailor the chemical and molecular architecture of polymer nanoparticles.

Synthetic nanoparticles have been obtained with high yields and through-puts by pulsed electron-beam irradiation of dilute aqueous solutions of water-soluble biocompatible polymers. In particular, carboxyl functionalized nanogel systems (NG) have been generated by pulsed e-beam irradiation of semi-dilute aqueous solutions of poly(N-vinyl pyrrolidone) (PVP) in the presence of acrylic acid [1]. This process simultaneously ensures polymer cross-linking, monomer grafting and sterilization of the produced materials [2].

Biodegradable, polysaccharide-based nanoparticles have been prepared with a degalactosylated variant of xyloglucan (Deg-XG) [3], that shows a thermally induced coil to globule transition at 37°C (figure 2). ⁶⁰Co γ -irradiation has been applied on the solid powder in air, up to a maximum dose of 60 kGy, to modify the polymer molecular weight distribution and, in turn, affect the coil-to-globule transition kinetics in water.

Both these synthetic and natural nanoparticles exhibit controlled size at the nanoscale, with hydrodynamic diameters of about 50 nm and 200 nm, respectively; colloidal stability in physiological conditions; and a large number of functional groups.

Physical incorporation and/or chemical (bio-)conjugation strategies have been developed to either decorate the surface of the nanoparticles with targeting agents, paramagnetic ion-chelating

moieties or proteins; or to entrap LMW drugs. Absence of cytotoxicity on different cell cultures has been demonstrated.



Figura 2 - AFM image of AA-grafted-PVP



Figura 1 - SEM image of Deg-XG nanoparticles, after incubation at 37°C

References

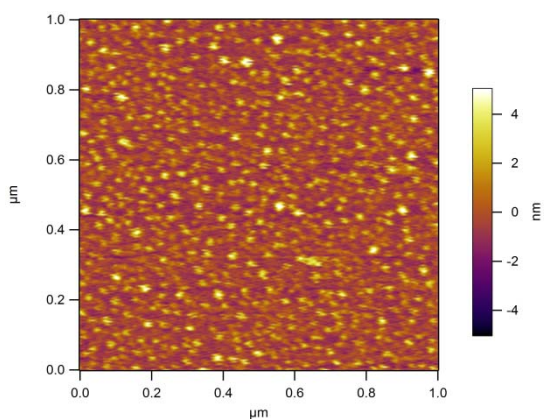
- [1] Dispenza C, Sabatino MA, Grimaldi N, Bulone D, Bondi ML, Casaletto MP, Rigogliuso S, Adamo G, Gheri G., *Biomacromolecules*, 13, 1805-1817 (2012).
- [2] Sabatino MA, Bulone D, Veres M, Spinella A, Spadaro G, Dispenza C., *Polymer*, 54(1), 54-64 (2013).
- [3] N. Grimaldi, M.A.Sabatino, G.Przybytniak, I.Kaluska, M.L.Bondi, D.Bulone, S. Alessi, G.Spadaro, C.Dispenza, *Radiat. Phys. Chem.* 94, 76-79 (2014).
- [4] C. Dispenza, G. Adamo, M. A. Sabatino, N. Grimaldi, D. Bulone, M. L. Bondi, S. Rigogliuso, G. Gheri, *J. Appl. Polym. Sci.*, 131(2), 39774-39782 (2014).
- [5] M. Shirakawa, K. Yamatoya, K. Nishinari, *Food Hydrocolloids*, 12, 25-28, (1998).
- [6] Todaro S, Sabatino MA, Walo M, Mangione MR, Bulone D, Dispenza C. *Radiat. Phys. Chem.*, 94, 245-248 (2014).

Photodegradation of 4-Nitrophenol (4-NP) in Aqueous Suspension by Using Titanium Phosphates $\text{Li}_{0.5}\text{M}_{0.25}\text{Ti}_2(\text{PO}_4)_3$ ($M = \text{Ni}, \text{Mn}$ and Co) Catalyzed Processes

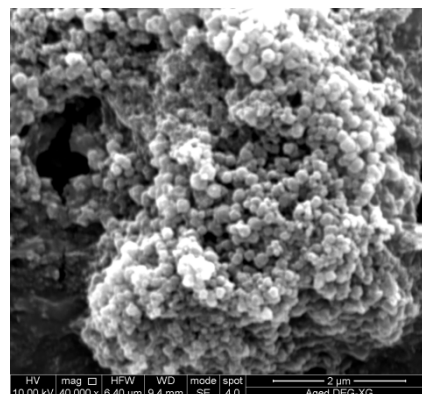
Khadija Eddahaoui^{1,2}, Giuseppe Mele¹, Said Benmokhtar², Rachid Essehli³, Iolanda Pio¹, Anna Scarlino¹

¹Department of Engineering for Innovation, University of Salento, Via Arnesano, 73100 Lecce, Italy

²Université Hassan II-Mohammédia, Faculté des Sciences Ben M'sik, Laboratoire de Chimie Physique des Matériaux, .Département de Chimie, Casablanca, Maroc

³Qatar Environment and Energy Reseach Institute (QEERI) Bg CP4, Qatar Foundation, Doha, Qatar

Email: khadija_eddahaoui@yahoo.fr

ABSTRACT

Photocatalytic degradation of 4-nitrophenol was investigated using titanium phosphates $\text{Li}_{0.5}\text{M}_{0.25}\text{Ti}_2(\text{PO}_4)_3$ ($M = \text{Ni}, \text{Mn}$ and Co) catalysts under UV-Visible light irradiation in aqueous dispersions in the presence of H_2O_2 .

Keywords: Nasicon-Phosphates; Crystal structure; ^{31}P MAS, FTIR spectra; Photodegradation

It has been shown that phenolic compounds are widely used and have become common pollutants in water bodies [1]. Due to their stability and bio-accumulation, they remain in the environment for longer periods. As they have high toxicity and a carcinogenic character, they have caused considerable damage and threat to the ecosystem in water bodies and human health. An effective and economic treatment for eliminating phenolics in water has been in urgent demand. TiO_2 is the most used photocatalyst, due to its (photo) stability and low cost [2]. Recently many studies have been reported [3] on preparation and characterization of various nanostructured materials because it has been found that the nanoparticles exhibit special photochemical characteristics; in particular, the bandgap of the nanoparticles increases with the decrease of the size and other important properties such as optical and physical absorption and luminescence emission undergo drastic changes.

In this work different nanostructured materials were prepared by sol-gel method: $\text{Li}_{0.5}\text{M}_{0.25}\text{Ti}_2(\text{PO}_4)_3$ with $M = \text{Ni}, \text{Co}$ and Mn . The samples were characterized by X-ray diffraction, ^{31}P magic-angle spinning nuclear magnetic resonance (MAS-NMR), Scanning Electron Microscopy (SEM), Energy Dispersive Analysis by X-Rays (EDAX), IR and UV-Visible spectroscopies.

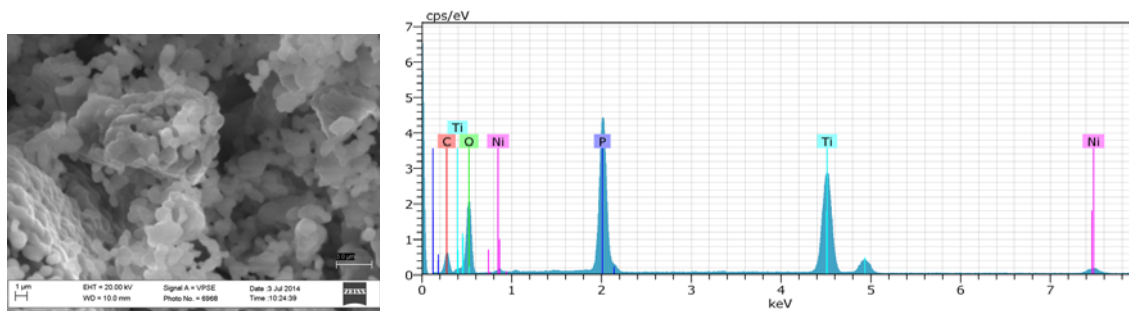

Fig 1. SEM image and EDAX spectrum of $\text{Li}_{0.5}\text{Ni}_{0.25}\text{Ti}_2(\text{PO}_4)_3$

The SEM image and EDAX spectrum of $\text{Li}_{0.5}\text{Ni}_{0.25}\text{Ti}_2(\text{PO}_4)_3$ have been reported in Figure 1.

As shown in Figure 2, the phases $\text{Li}_{0.5}\text{Ni}_{0.25}\text{Ti}_2(\text{PO}_4)_3$, $\text{Li}_{0.5}\text{Co}_{0.25}\text{Ti}_2(\text{PO}_4)_3$ and $\text{Li}_{0.5}\text{Mn}_{0.25}\text{Ti}_2(\text{PO}_4)_3$ showed good activities by carrying out the degradation of 4-nitrophenol (4-NP) as probe reaction in aqueous suspension under heterogeneous photo-Fenton-type reactions by using UV-visible light.

However, it can be noticed that the photocatalytic activity decreases in following order:

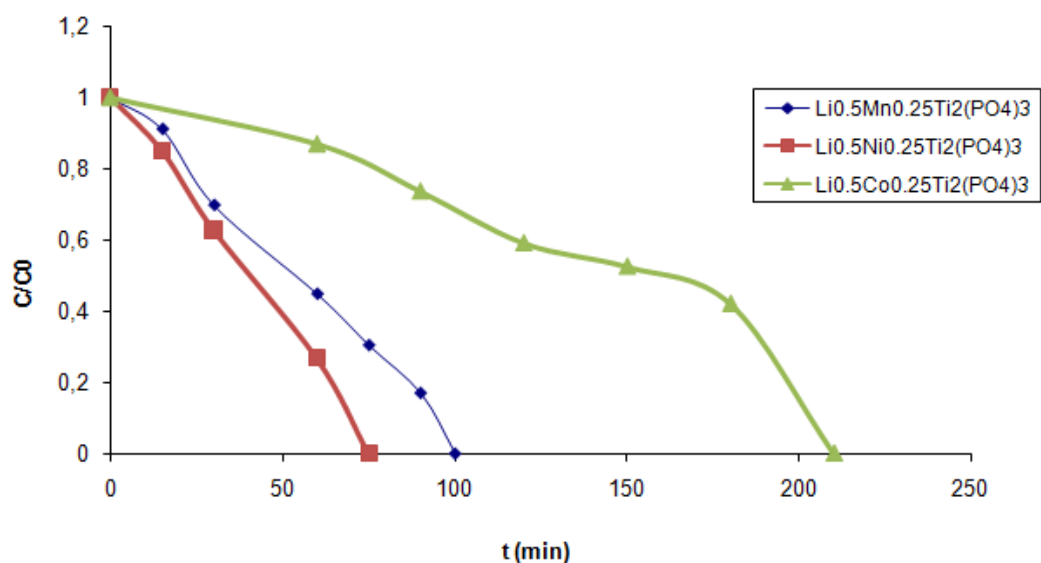
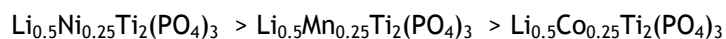

Fig.2 Degradation of 4-NP as a function of irradiation time in the presence of different photocatalysts, with H_2O_2 and air bubbling. Experimental conditions: $[\text{4-NP}] = 20 \text{ mgL}^{-1}$, catalyst amount: 0.08 gL^{-1} ; reaction volume= 300 mL; lamp: UV-vis lamp SANOLUX, 300 W.

The mechanism of degradation of 4-NP is under investigation.

In conclusion, we have demonstrated as combined H₂O₂/ Nasion-type phosphates based processes can be applied as effective catalysts for degradation of organic pollutants in aqueous solution such as industrial wastewater and polluted water resources.

References

- [1] L.H. Kieth, EPA's priority pollutants AIChE Symp. Ser., Water 77(209) (1980) 249.
- [2] A. Fujishima, K. Hashimoto, T. Watanabe, TiO₂ Photocatalysis: Fundamentals and Applications. Bkc, (1999), Tokyo
- [3] G. Mele, I. Pio, Anna S., E. Bloise, R. Del Sole, L. Palmisano, and G. Vasapollo, Hindawi Publishing Corporation, Journal of Catalysts, Article ID 376078, 7 (2013).

Catalytic Wet Air Oxidation of bilge waters with carbon supported $MnCeO_x$ catalysts

Claudia Espro¹, Shahul Hameed Abdul Rahim¹, Francesco Arena¹, Giuseppe Trunfio¹, Candida Milone¹ and Signorino Galvagno¹

Department of Electronic Engineering, Chemistry and Industrial Engineering
University of Messina, Messina, Italy
Email: espro@unime.it

ABSTRACT

Waste waters generated by onshore and offshore industry and from engine rooms of ships (bilge waters) have an high level of oil content then strictly require to be treated prior being discharged. The objective of this work was to investigate the feasibility of bilge waters treatment by Catalytic Wet Air Oxidation process (CWAO).

Keywords: Oily wastewaters, bilge water, CWAO, Activated carbon, CNTs, $MnCeO_x$ supported catalysts

Bilge water is a difficult wastewater to treat as it has high salt content, suspended solids, used oils and detergents [1]. In this context, the heterogeneous CWAO, which involves the oxidation of these organic compounds into more biodegradable compounds or their mineralization to CO_2 , is a very promising tool to purify this kind of wastewater [2]. Among the polluting organic compounds present in bilge water, hardly biodegradable phenolic derivatives are present in large amount, therefore phenol has been selected as model molecule. Reaction was carried out at $150^\circ C$ and $P_{air}=14$ bar, using $MnCeO_x$ supported catalysts (0.75 g) in an aqueous solution of phenol (1000 ppm). In order to study the effect of carbonaceous supports on catalyst texture, dispersion and redox properties of metallic phases, a series of 10% $MnCeO_x$ (with a Mn/Ce molar ratio of 1/1) supported on activated carbon (AC) and carbon nanotubes (CNTs) have been prepared. Catalytic activity of the investigated catalysts ($MnCeO_x/AC$ and $MnCeO_x/CNTs$) prepared via redox-precipitation and incipient wetness methods, is presented in Figure 1 and Figure 2

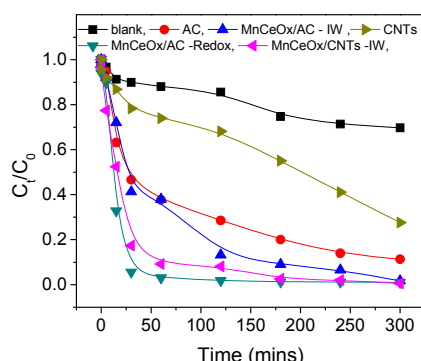

Figure 1: Phenol removal vs contact time

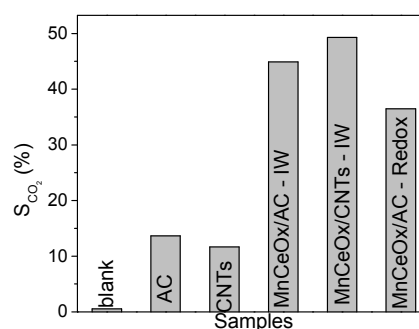

Figure 2: Selectivity toward CO_2 formation with different catalysts.

It should be noted that in absence of catalyst (blank experiment) phenol conversion of 30% is achieved and that it even increases up to 89% and 72% when the reaction is carried out with unloaded AC and CNTs, respectively (Figure 1). The addition of Mn and Ce to carbonaceous support leads to an enhancement of the catalytic activity leading to an almost complete phenol removal, under condition investigated (Figure 1). Among the catalysts investigated, the $MnCeO_x/CNTs$ prepared by wetness impregnation shows the better mineralization activity ($S_{CO_2} \% \approx 50$) (Figure 2). A preliminary account of the physical-chemical and morphological properties of catalytic materials, determined by means of TPR, SEM, TEM, XRD, BET and TGA, will be reported.

References

- [1] J.M. Benito, M.J. Sánchez, P. Pena, M.A. Rodríguez, Desalination 214, 91-101, (2007)
[2] M. S.-Sánchez, A. M.-Valiente, J. Á.-Rodríguez, V. M.-Andrés, I. R.-Ramos, A. G.-Ruiza, Appl. Catal.B: Environ. 104, 101-109, (2011)

Synthesis, characterization and aggregation properties of a Zinc(II) salen Schiff-Base complex derived from 1,2-cyclohexanediamine

Giuseppe Consiglio¹, Santo Di Bella², Salvatore Failla¹, Ivan Pietro Oliveri² and Paolo Finocchiaro¹.

¹Dipartimento di Ingegneria Industriale, Università di Catania, I-95125 Catania, Italy, sfailla@dii.unict.it

²Dipartimento di Scienze Chimiche, Università di Catania, I-95125 Catania, Italy, sdibella@unict.it.

ABSTRACT

The synthesis, characterization and study of the aggregation properties in solution of non-coordinating solvents of a Zn(salen) Schiff-Base complex derived from 1,2-cyclohexanediamine, through detailed ¹H NMR, DOSY NMR, and optical absorption spectroscopy investigations, are reported. It is found that in solution of non coordinating solvents various aggregate species are present. This behavior may be related to the non-conjugated, conformational nature of the bridging diamine of the Schiff-base.

Keywords: Zn^{II} salen complexes, Self-assembly, Chiral complex.

Tetracoordinated Zn^{II} Schiff-base complexes are Lewis acidic species that saturate their coordination sphere by coordinating a large variety of Lewis bases with formation of monomeric species, or in their absence, can be stabilized through intermolecular Zn^{II}...O axial coordination involving Lewis basic atoms of the ligand framework with formation of aggregated systems.^{1,2} Alternatively, the appropriate design of ligands possessing flexible Lewis donor atoms as side substituents, suitable to axially coordinated the Zn^{II} atom of another molecular unit, allows the achievement of new tailored Zn^{II} supramolecular architectures.³ For the amphiphilic bis(salicylaldiminato)Zn^{II} Schiff-base complexes having conjugated diamine bridge, the degree of aggregation is influenced by nature of the bridging diamine and concentration of the solution.^{1,2}

This contribution presents the study of the aggregation behaviour of a bis(salicylaldiminato)Zn^{II} Schiff-base complex having a conformational flexible bridging diamine, such as the 1,2-cyclohexanediamine. Through detailed ¹H NMR, DOSY NMR and optical spectroscopic studies, it is found the existence of several species in solution of non-coordinating solvents, with a different disaggregation behaviour and coordination mode around the metal center.

References

- [1] G. Consiglio, S. Failla, P. Finocchiaro, I. P. Oliveri, R. Purrello, S. Di Bella, *Inorg. Chem.*, **49**, 5134-5142, (2010).
- [2] G. Consiglio, S. Failla, P. Finocchiaro, I. P. Oliveri, S. Di Bella, *Dalton Trans.*, **41**, 387-395, (2012).
- [3] I. P. Oliveri, S. Failla, G. Malandrino, S. Di Bella, *New J. Chem.*, **35**, 2826-2831, (2011).

FT-IR studies on PEG-based and Brij-based hybrid organo-inorganic materials

Elisabetta Finocchio¹, Paola Gallo Stampino², Cinzia Cristiani²

¹ Dipartimento di Ingegneria Civile, Chimica e Ambientale, P.le J.F.Kennedy 1, Università di Genova, 16129 Genova, Italy.

² Dipartimento di Chimica, Materiali e Ingegneria Chimica "G. Natta", Politecnico di Milano, Piazza Leonardo da Vinci 32, 20133 Milano, Italy

Email: Elisabetta.Finocchio@unige.it

ABSTRACT

PEG and BRJI modified montmorillonite clays have been investigated both at room temperature and at increasing temperatures through *in situ* FT IR spectroscopy to obtain insight on the interactions between the organic moieties and the inorganic matrix.

Keywords: organoclays, FT-IR spectroscopy, PEG polymer

Polymer-modified clays are a class of hybrid organic-inorganic materials showing a wide range of applications (environmental remediation, catalysis, biomedical application). Very recently, the intercalation of water-soluble PEG molecules and polyethylene oxide BRIJ within the montmorillonite clay (STx) interlayers has been successfully obtained from water solution intercalation and these materials and their ability to arrange organic molecules within the layers has been investigated by several techniques [1,2]. In particular, IR data allow a better understanding of the interactions between the organic moieties and the inorganic matrix at molecular level (for instance: the polymer conformation in the interlayer space, the interaction of the -CH₂CH₂O- units with the matrix cations and the interlayer water molecules [2]).

In the present work we propose a systematic investigation of the thermal evolution of PEG and BRJI -montmorillonite (STx) composite materials, analyzing by FT IR spectroscopy in the 70-450 °C temperature range the condensed phase species as well as the gaseous species. The behavior of several IR bands in the mid-IR region towards heating has been followed and proposed as diagnostic of the matrix-polymer interaction. Thermal degradation of PEG based and BRJI intercalated montmorillonite is a multi step process, PEG fragmentation through the cleavage of the C-O bond appears to be the main reaction step, leading to the formation of short chain adsorbed species. The detection of carbonyl band (1700-1720 cm⁻¹) is diagnostic of the formation of partial oxidation products as first step of the thermal degradation. Increasing polymer loadings, as well as increasing polymer molecular weight leads to lower temperature of formation of the first oxidation products. CH stretching bands (2800-3000 cm⁻¹) detected at 450-500 °C indicated the formation of residual organic compounds resisting oxidation, preserved from further oxidation by the interlayer galleries. The position and intensity of the water deformation band (1630 cm⁻¹) evidenced the interaction of PEG hydrophilic moieties with montmorillonite hydration water, competing for cations coordination. Hydration water is still detectable at high temperatures as a further indication of its stabilization by interaction with organic fragments through H-bonds.

References

- [1] E.Finocchio, I.Baccini, C.Cristiani, G.Dotelli, P.Gallo Stampino, L.Zampori, *The Journal of Physical Chemistry A*, 115, 7484-93, (2011).
- [2] E.Finocchio, C.Cristiani, G.Dotelli, P.Gallo Stampino, L.Zampori, *Vibrational Spectroscopy* 71, 47-59, (2014).

Doped Nickel Catalysts for Ethanol-Phenol Steam Reforming

Elisabetta Finocchio, Gabriella Garbarino, Sahar Chitsazan, Gianguido Ramis, Guido Busca

Dipartimento di Ingegneria Civile, Chimica e Ambientale, P.le J.F.Kennedy 1, Università di Genova, 16129 Genova, Italy.

Email: Elisabetta.Finocchio@unige.it, Gabriella.Garbarino@unige.it

ABSTRACT

The steam reforming of ethanol/phenol mixture assumed as a model for tar mixtures, has been tested over silica stabilized Ni/Al₂O₃ catalyst, and over Boron and Magnesium catalysts. Catalysts have been characterized by XRD, IR of adsorbed CO, TPR, UV-vis spectroscopies and the effects of reaction temperature and of the presence of sulphur have been investigated in reactivity tests. The effects of the addition of are here discussed.

Keywords: Steam Reforming; tars; Ni/Al₂O₃ catalyst.

The production of renewable hydrogen can be performed through biomass gasification, followed by treatment of the resulting syngas. This process is hampered by the presence of tars (a complex mixture of heavier and lighter oxygenated organic compounds) in the syngas. The most promising industrial strategy for tar abatement after biomass gasification seems to be catalytic Steam Reforming, particularly over Ni-Al₂O₃ based catalysts.

Silica-stabilized Ni/Al₂O₃ catalyst, 20%wt NiO (5% SiO₂-95% Al₂O₃), with a partial coverage of a theoretical monolayer of NiO has proven to be an active steam reforming catalyst for ethanol-phenol mixture as a model for biomass tar at 873 K, and above, leading to high ethanol and phenol conversion, good hydrogen yields and low selectivity to heavy reaction products. Conditioning of the catalysts in the reaction medium at higher temperature, up to 1023 K, is required in order to obtain the best results [1,2]. In the very same conditions Mg-doped catalyst (20% wt MgO) is the best catalyst with total conversion of the to steam reforming products and small amounts of methane, and hydrogen yield 0.84. However, the addition of Magnesium also increases sensitivity to sulphur poisoning (tested by feeding pulses of tetrahydrothiophene in the flow reactor). XRD, IR and TPR data suggest that the activating effect of Mg may be related to the competition of Mg²⁺ with respect to Ni²⁺ for the interaction with the alumina support surface. The previous deposition of Mg salt on the support, in fact, limits the dispersion of Ni²⁺ favouring the formation of bigger NiO particles, whose reduction leads to larger Ni particles formation. The presence of CO itself that may also favour building of larger particles through gas phase migration of Ni(CO)₄. The result is the formation of typically large Ni particles where CO adsorbs both on-top and in bridging configuration. On the other side, according to IR experiments, Boron seem to reduce the amount of available Ni metal centers, mainly of the isolated reduced Ni centers. This likely occurs because of covering the Ni metal surface by borate species. A slight positive effect in reducing the deactivation due to sulphur is observed when Boron is added after Nickel.

References

- [1] G.Garbarino, A.Lagazzo, P.Riani, G. Busca, *Applied Catalysis B: Environmental* 129, 460-72, (2013)
- [2] G. Garbarino, E. Finocchio, A. Lagazzo, I. Valsamakis, P. Riani, V. Sanchez Escribano, G. Busca, *Applied Catalysis B: Environmental*, 147, 813-26, (2014).

Aza[6]helicenes: synthetic strategies and physico-chemical properties.

Francesca Fontana¹, Federica Melone¹, Isabella Natali Sora¹, Andrea Mele², Daniele Mendola².

¹Dipartimento di Ingegneria, Università di Bergamo, viale Marconi 5, 24044 Dalmine BG, Italy

² Dipartimento di Chimica, Materiali e Ingegneria Chimica "G.Natta", Politecnico di Milano, Piazza L. Da Vinci 32, 20132 Milano, Italy

Email: fontana@unibg.it

ABSTRACT

Several synthetic protocols were explored for the optimization of the synthesis of mono- and diaza[6]helicenes. These molecules are prepared and characterized in view of optoelectronic, biological and sensoristic applications

Keywords: Azahelicenes, photocyclization, physico-chemical properties

Following the studies performed in this research group in the recent years, attempts are being made for the synthesis of mono- and diaza[6]helicenes in order to combine known reactions to optimize the synthetic strategy and obtain reasonable amounts of different target molecules:

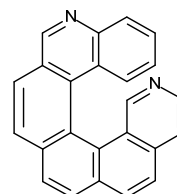
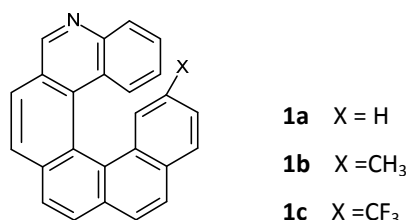

Figure 1: Monoaza[6]helicene. X = H, CH₃, CF₃

Figure 2: 2,12-Diaza[6]helicene (**2**)

Molecule **1a** was recently the object of a physico-chemical study¹ in which the separated enantiomers of the inherently chiral helical compound were investigated for their spectroscopical behaviour, particularly for Circularly Polarized Luminescence. This latter spectroscopical feature appears to be strongly influenced by the substituents onto the aromatic backbone, so that introduction of a non-polar (as in **1b**) or of a strongly electron-withdrawing (**1c**) substituent should exhibit a marked effect on CPL spectra. Therefore, synthetic strategies were explored to obtain these new compounds. On the other hand, a non-symmetrical diaza[6]helicene (**2**) was prepared with the purpose of exploiting the presence of two non-conjugated nitrogen atoms, one for quaternarization and the other for complexation. The interest of azahelicenes lies in the possibility of utilizing helicenes' remarkable properties (strong fluorescence emission, inherent chirality, strong UV absorption, self-assembling ability etc.) for several kinds of applications, since the nitrogen atom(s) in the molecular backbone can be exploited for functionalization and metal ion complexation.²

References

- [1] S. Abbate et al., *J. Phys. Chem. C* 118, 1682–1695, (2014).
[2] T. Caronna et al., *Molecules* 17, 463–479 (2012).

FTIR spectral signatures of human Granulosa Cells: characterization of molecular markers

E. Giorgini¹, G. Gioacchini¹, L. Vaccari², S. Sabbatini³, C. Conti³, A. Borini⁴,
O. Carnevali¹, G. Tosi¹

¹Dipartimento DISVA, Università Politecnica delle Marche, 60131 Ancona, Italy

²SISSI Beamline, Elettra Synchrotron Light Laboratory, Trieste, Italy

³Dipartimento SIMAU, Università Politecnica delle Marche, Ancona, Italy

⁴Tecnobios Procreazione, Centre for Reproductive Health, Bologna, Italy

E-mail: e.giorgini@univpm.it

ABSTRACT

Granulosa Cells (GCs) are somatic cells, which surround and exhibit a strong and complex relationship with oocytes. GCs play a determining role in oocyte competence acquisition and, hence, in the decline of its quality, sometime inducing sterility. The present study has been carried out to improve knowledge on GCs mechanisms and metabolic processes by using, for the first time, Fourier Transform Infrared Microspectroscopy.

Keywords: Granulosa Cells, FTIR, multivariate analysis

A comprehensive set of macromolecular data has been collected on GCs from idiopathic patients at different ages (**A**, 29±3 and **B**, 43±3 years old), both air-dried (CaF₂ supports) and in living conditions (DMEM solution with an *in house-build* biocompatible IR-visible microfluidic device). The results have been compared to evaluate the reliability and reproducibility of these procedures (Fig. 1a).

A and **B** spectral data have been submitted to HCA, PCA and SIMCA analyses, affording to a satisfactory segregation (Fig. 1b). For **A** and **B** groups, average spectra were analyzed in the following spectral regions: 3100-2800 (CH_{2/3} stretching modes), 1800-1450 (Amide I and II), and 1300-900 (phosphates and carbohydrates moieties) cm⁻¹.

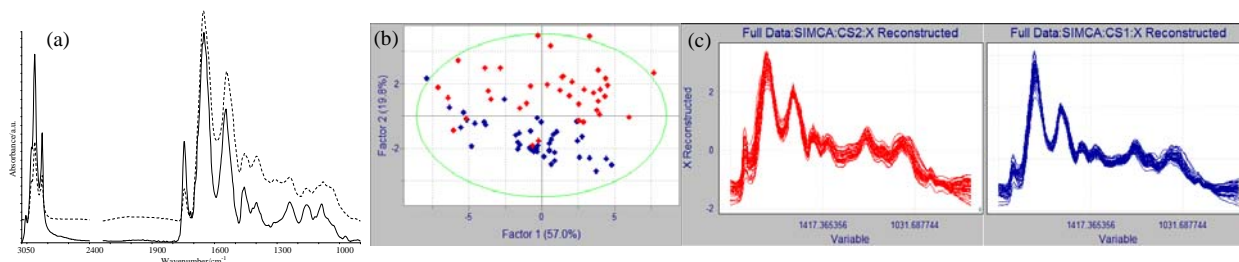

Figure 1: (a) IR average spectra of GCs acquired in DMEM solution (continuous line), and air dried (dotted line): (b) PCA scores plot. and (c) X reconstructed of A (blue) and B (red) samples.

References

- [1] G. Gioacchini, E. Giorgini, L. Vaccari, P. Ferraris, S. Sabbatini, V. Bianchi, A. Borini, O. Carnevali, *Fert. Ster.* 101, 120 (2014).
- [2] E. Giorgini, C. Conti, P. Ferraris, S. Sabbatini, G. Tosi, C. Rubini, L. Vaccari, G. Gioacchini, O. Carnevali, *Anal. Bioanal. Chem.* 398,3063 (2010).
- [3] N.B. Karuputhula, R. Chattopadhyay, B. Chakravarty, K. Chaudhury, *Syst. Biol. Reprod. Med.*, 59(2), 91 (2013).

Flame-retardant and anti-dripping properties of polyester treated via sol-gel with boehmite nanoparticles

E. Guido¹, J. Alongi², C. Colleoni¹, G. Malucelli², G. Rosace¹

¹ Department of Industrial Engineering, University of Bergamo, viale Marconi 5, 24044, Dalmine (BG), Italy

² Department of Applied Science and Technology, Politecnico di Torino (Sede di Alessandria), Viale Teresa Michel 5, 15121 Alessandria, Italy

Email: giuseppe.rosace@unibg.it

ABSTRACT

Polyester fabrics were treated with hybrid organic-inorganic sols containing nanoparticles of boehmite in presence of 3-glycidoxypropyltrimethoxysilane (GPTMS). The treated fabrics were analyzed by FT-IR spectroscopy, SEM-EDX and thermogravimetric (TG) analysis. In addition, flammability tests were performed to evaluate the behaviour of the different components of the mixture applied onto surface fabric separately. The results obtained have shown a synergistic effect between the GPTMS and the nanoparticles of boehmite, able to slow the combustion and to suppress the dripping, that is the main problem during the combustion of the polyester.

Keywords: Polyester, sol-gel technology, flam-retardancy, boehmite nanoparticles.

In this study bifunctional 3-glycidoxypropyltrimethoxysilane (GPTMS) precursor, containing methoxysilyl groups and an epoxy group, was used to synthesize an hybrid organic-inorganic coating for textile finishing. It was chosen because it combines excellent properties like the possibility to anchor specific molecules (through the reactive epoxy function) and the binding capacity with the textile surface (through the hydrolyzed Si-OH groups). This immobilization technique, previously studied [1, 2], has been employed to prepare thin films in the presence of nanoparticles of boehmite (AlOOH), a precursor of the transition alumina compounds, widely used in the industry of adsorbents and catalysts. The thermal stability and flame resistance of polyester (PET) fabrics treated were studied using thermo gravimetric analysis and flammability test, respectively. In addition, the morphology and surface composition of untreated and treated samples were performed by SEM-EDX analysis. Figure 1 shows the SEM images of untreated PET and treated PET with GPTMS-Boehmite sol.

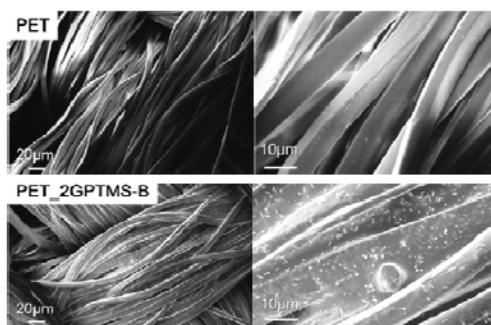





Figure 1: SEM micrographs of untreated and treated PET samples.

The treated fibers show a uniform distribution of microaggregates attributable, according to the EDX analysis, to both the silica component and the nanoparticles of boehmite. The thermal and

thermo-oxidative stability of untreated and treated fabrics has been studied by thermogravimetry in nitrogen and air, respectively, indicating an alteration of the combustion process compared to untreated PET, especially in air. In particular, the presence of the GPTMS-B coating anticipated the degradation process of PET and, at the same time, released a final residue greater than the untreated fabric. From the analysis performed on the samples treated with boehmite and with GPTMS, it was possible to clarify that the GPTMS is the active element of the mixture that acts as an inhibitor of the combustion process.

Melt dripping is one of the most important problems related to the combustion of the polyester: indeed, the melting and flaming drops can either remove the polymer fuel from the burning region, hence stop further burning or can act as secondary source of ignition [3,4]. In Table 1 the results of the flammability test performed on the untreated sample and on PET treated with boehmite (PET-B), GPTMS (PET-GPTMS) and GPTMS-B (PET-GPTMS-B) are reported. The best result was obtained with the sample treated with GPTMS-B, that acts as a suppressor of smoke, of dripping and it gives a higher final residue compared to the other analyzed samples. Moreover, the final residue left by PET-GPTMS-B is consistent because of applied coating. Indeed, the SEM observations have shown that, during combustion, the texture is maintained and the coating is able to protect the fibres from the fire. So, the fibres are partially consumed on the surface but the coating is still visible, as confirmed by EDX analysis.

Table 1: Flammability data of untreated and treated Polyester samples.

Campione	t_{goccia} (sec)	$t_{\text{totale di combustione}}$ (sec)	Residuo (%)	Immagini
PET	8	12	20	
PET_B	9	22	21	
PET_GPTMS	//	56	28	
PET_GPTMS-B	//	34	37	

In conclusion, the treatment of the fabrics with a sol containing both boehmite and GPTMS has strongly enhanced the flame resistance of the polyester, as confirmed by the increase of the final residue and by the dripping suppression as well. Thus, the proposed halogen-free and environmentally-friendly flame retardant finishing, which does not involve phosphorus, nitrogen or heavy metals, could advantageously replace current flame retardants used in traditional wet chemical applications.

References

- [1] M. Caldara, C. Colleoni, E. Guido, V. Re, G. Rosace, *Sensor Actuat. B-Chem.*, 171, 1013-1021, (2012).
- [2] L. Van der Schueren, K. De Clerck, G. Brancatelli, G. Rosace, E. Van Damme, W. De Vos Novel, *Sensor Actuat B-Chem* 162:27-34 (2012).
- [3] B. K. Kandola, D. Price, G. J. Milnes, A. Da Silva, *Polym. Degrad. Stabil.*, 98, 52-63, (2013).
- [4] E. Guido, J. Alongi, C. Colleoni, A. Di Blasio, F. Carosio, M. Verelst, G. Malucelli, G. Rosace *Polym Degrad Stabil*, 98, 1609-1616, (2013).

Precursori alluminosilicatici sostenibili per geopolimeri

Isabella Lancellotti¹, Chiara Ponzoni¹, Flavia Bollino², Michelina Catauro², Luisa Barbieri¹, Cristina Leonelli¹

¹*Department of Engineering "Enzo Ferrari", University of Modena and Reggio Emilia, 41125 Modena, Italy*

²*Department of Industrial and Information Engineering, Second University of Napoli, Aversa, Italy*

Email: isabella.lancellotti@unimore.it

ABSTRACT

Nel presente contributo ceneri pesanti provenienti dall'incenerimento dei rifiuti urbani, pretrattate in apposito impianto, sono state utilizzate come matrice alluminosilicatica per l'ottenimento di geopolimeri attraverso attivazione alcalina. I materiali sintetizzati sono stati caratterizzati a tempi di stagionatura fissati (3h; 1, 4, 5, 7, 30 giorni; 20 mesi) attraverso diffrazione a raggi X (XRD) e spettroscopia infrarossa (FTIR) per ottenere informazioni sull'evoluzione strutturale e sul procedere del processo di geopolimerizzazione. L'effetto del tempo di stagionatura influisce sia sulla trasformazione delle fasi cristalline che sulla struttura del gelo geopolimerico. I risultati della diffrazione mostrano che la geopolimerizzazione inizia già nelle prime 3 ore di invecchiamento. Nuove fasi cristalline come carbonato di sodio idratato e silicoalluminato di calcio idrato (gismondino) appaiono dopo 3 ore e dopo 1 giorno, rispettivamente, confermando la reattività progressiva della cenere pesante. La spettroscopia FTIR mostra uno spostamento di 40 cm^{-1} della banda a 980 cm^{-1} durante le prime ore di stagionatura confermando la formazione di un reticolo geopolimerico anche in assenza di metacaolino, principale materia prima naturale per l'ottenimento di geopolimeri. La microscopia elettronica a scansione conferma la presenza di gelo geopolimerico e un contenuto di particelle non reagite che diminuisce con il tempo. Il materiale solido ottenuto, che contiene 100% in peso di cenere pesante di inceneritore, presenta una microstruttura porosa, dovuta al contenuto di metalli nella cenere stessa, con una densità apparente comparabile a materiali alleggeriti riportati in letteratura.

Keywords: ceneri pesanti di inceneritore, attivazione alcalina, valorizzazione, consolidamento a freddo

Biodegradable aliphatic copolyesters containing thio-ether linkages for sustainable food packaging applications

Nadia Lotti¹, Laura Genovese¹, Massimo Gazzano², Lara Finelli¹, Valentina Siracusa³, Marco Dalla Rosa⁴, Andrea Munari¹

¹Civil, Chemical, Environmental and Materials Engineering Dept., University of Bologna, Via Terracini 28, 40131 Bologna, Italy.

²Organic Synthesis and Photoreactivity Institute, CNR, Via Selmi 2, 40126, Bologna, Italy.

³Industrial Engineering Dept. University of Catania, Viale A. Doria 6, 95125 Catania, Italy.

⁴Agro-food Science and Technology Dept., University of Bologna, Piazza Goidanich, 60 47521 Cesena, Italy.

Email: nadia.lotti@unibo.it

ABSTRACT

A series of novel random copolymers of poly(butylene succinate) (PBS) containing thiodiethylene glycol sub-unit (PBSPTDGS) were synthesized and characterized in terms of molecular and solid-state properties, among these barrier properties to different gases (oxygen and carbon dioxide). In addition, biodegradability studies in compost have been conducted. The main effect of copolymerization was a lowering of crystallinity degree (χ_c) and a decrease of the melting temperature compared to the parent homopolymer. The Baur's equation well described the T_m -composition data. Final properties and biodegradation rate of the materials under study were strictly dependent on copolymer composition and χ_c . As to the barrier properties, the copolymers showed improved barrier properties with respect to polylactide films tested under the same conditions. Lastly, the biodegradation rate of PBSPTDGS copolymers increased with the increasing of TDGS mol %.

Keywords: poly(butylene succinate); thiodiethylene glycol; random copolymers; solid-state properties; biodegradability; polymer gas permeability.

The severe environmental problems, including the increasing difficulties of waste disposal and the deepening threat of global warming caused by the non-biodegradability of a number of polymers have raised concerns all over the world. The use of biodegradable counterparts as an alternative to non-biodegradable polymers is, therefore, evoking considerable interest. The compostability attribute is very significant for biopolymers because allows disposal of the packages in the soil by transforming it into water, carbon dioxide and inorganic compounds (1). Biodegradable or green packaging must accomplish basic requirements to be an ideal candidate for food, which includes barrier properties, transparency, strength, welding and molding properties, disposal requirements, antistatic properties and, above all, strictly follow food safety (2). Aliphatic polyesters have recently gained growing attention as suitable candidates for food packaging applications due to their biodegradability and ease of processing. On this ground, the present work concerned the synthesis and characterization of novel fully aliphatic PBS-based copolyesters which guarantee full biodegradability and offer suitable characteristics specially in terms of mechanical strength and barrier properties to be utilized in food packaging applications. The solid-state properties, wettability, gas barrier properties and biodegradation rate of the new random synthesized

poly(butylene/thiodiethylene succinate) copolymers (PBSPTDGS) (see Fig.1) have been related with copolymer composition.

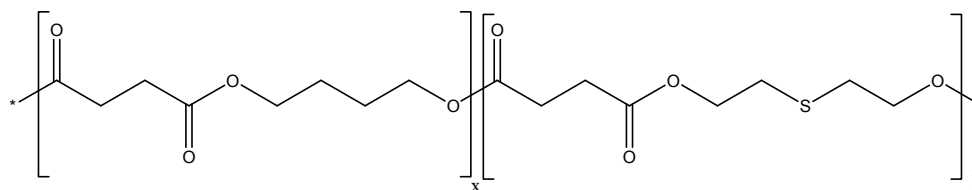

Fig. 1 Chemical structure of PBSPTDGS.

Experimental

Poly(butylene/thiodiethylene succinate) random copolymers PBSPTDGS of various composition have been synthesized according to the usual two stage melt-polycondensation, starting from dimethyl succinate (DMS) and different ratios of 1,4-butanediol (1,4-BD) and thiodiethylene glycol (TDG), using 20% molar excess of the glycol mixture with respect to dicarboxylic ester, employing $Ti(OBu)_4$ as catalyst. The synthesized PBSPTDGS copolymers have been characterized from the molecular (NMR and GPC), thermal (TGA, DSC), structural (WAXS) and mechanical (tensile tests) point of view. Biodegradation in compost has been also investigated. Lastly, the barrier properties to different gases (oxygen and carbon dioxide) has been studied.

Results and discussion

In all cases, the expected structure was verified and the final compositions was very similar to the feed one. All the samples are characterized by a good thermal stability (up to 315°C). All the polymers investigated are semicrystalline, the copolymer peak location depending on the copolymer composition. The increase in the amount of TDGS co-units in the macromolecular PBS chain leads to a reduction of the heat of fusion, indicating a reduced level of crystallinity in the copolymers with respect to the homopolymer PBS. The introduction of the more hydrophilic TDGS units into PBS chain has the effect of increasing polymer wettability, which increases with the TDGS content. Biodegradation rate is strongly affected by copolymer composition, in particular the higher the amount of TDGS co-units the faster the biodegradation. Mechanical as well as barrier properties are strictly correlated to copolymer composition too.

Conclusions

The copolymer composition appeared to be the key parameter in determining the characteristics of the samples under investigation. Physicochemical characterization demonstrated that by simply varying copolymer composition, it is possible to control polymer crystallinity, thermal and mechanical properties, wettability, gas barrier properties and biodegradation rate.

References

- [1] G. E. Luckachan and C. K. S. Pillai, "Biodegradable polymers - a review on recent trends and emerging perspectives". *Journal of Polymer and the Environment*, , 19, 637 (2011).
- [2] J. Ahmed and S. K. Varshney, "Polylactides - chemistry, properties and green packaging technology: a review". *International Journal of Food Properties*, , 14, 37, (2011).
- [3] V. Siracusa *et al.*, "Biodegradable polymers for food packaging: a review". *Trends in Food Science & Technology*, , 19, 634 (2008).

Novel biodegradable and biocompatible poly(butylene/triethylene succinate) random copolyesters with adjustable properties for tissue engineering

Nadia Lotti¹, Martina Fabbri², Massimo Gazzano³, Marco Govoni⁴, Emanuele Giordano^{4,5}, Lara Finelli¹, Rita Gamberini², Bianca Rimini², Andrea Munari¹

¹Civil, Chemical, Environmental and Materials Engineering Dept., University of Bologna, Via Terracini 28, 40131 Bologna, Italy.

²Department of Sciences and Methods for Engineering, University of Modena and Reggio Emilia, Via Amendola 2 - Padiglione Morselli, Reggio Emilia, Italy.

³Organic Synthesis and Photoreactivity Institute, CNR, Via Selmi 2, 40126, Bologna, Italy.

⁴Health Sciences & Technologies (HST) CIRI, Via Tolara di Sopra 50, Ozzano dell'Emilia (BO), Italy.

⁵Electrical, Electronic and Information Engineering "Guglielmo Marconi" Dept., University of Bologna, Viale Risorgimento 2, 40136 Bologna, Italy.

Email: nadia.lotti@unibo.it

ABSTRACT

The interest towards new elastomeric materials with low elastic modulus (E), suitable for soft tissue engineering applications (E in the range 0.1-100 MPa, according to the specific native tissue), has increased significantly in the last decade. In this work we propose new biomaterials exhibiting elastomeric properties. Newly synthesized random copolyesters poly(butylene/triethylene succinate) copolymers (PBSPTES) are presented and their solid-state properties and biocompatibility are investigated and correlated with copolymer composition.

Keywords: poly(butylene succinate); triethylene glycol; copolymers; solid-state properties; hydrolytic degradation; biocompatibility.

The use of biodegradable polymers in regenerative medicine has attracted considerable attention in recent years. This is mainly because, thanks to their hydrolysis in the human body, the need of surgery to remove the implant can be avoided. Of course, to be employed as biomaterials, these polymers need to show excellent biocompatibility and the degradation products must be nontoxic to the organism.[1] Moreover, their biodegradation rate has to satisfy the requirements according to the intended function.[1] Among other classes, aliphatic polyesters (APs), have been widely used as they combine proven biodegradability with good biocompatibility and promising mechanical properties.[2] Poly(butylene succinate) (PBS) undoubtedly represents one of the most interesting APs, as it is commercially available, it can be easily processed into various forms and structures and it possesses mechanical properties resembling those of PE and PP.[3] However, while PBS is suited to applications requiring high resistance, it is too rigid to be exploited for soft tissue engineering applications. Moreover, its degradation kinetics is too slow for some applications. With the aim of improving PBS wettability and mechanical properties, novel PBS-based random copolymers containing ether linkages (PBSPTES) are here presented. The solid-state properties, hydrolytic degradation profiles and biocompatibility of the new random synthesized poly(butylene/triethylene succinate) copolymers (PBSPTES) (see Fig.1) have been related with copolymer composition.

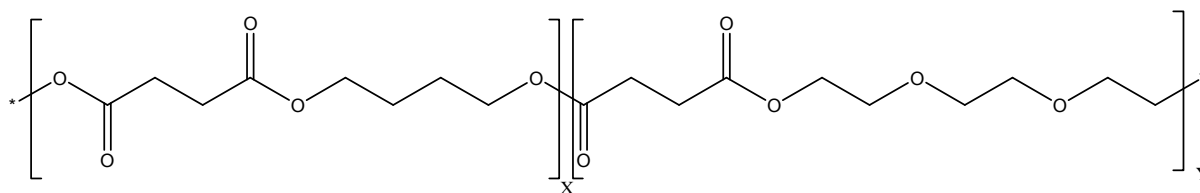

Fig. 1 Chemical structure of PBSPTES.

Experimental

Poly(butylene/triethylene succinate) random copolymers PBSPTES of various composition have been synthesized according to the usual two stage melt-polycondensation, starting from dimethyl succinate (DMS) and different ratios of 1,4-butanediol(1,4-BD) and triethylene glycol (TEG), using 20% molar excess of the glycol mixture with respect to dicarboxylic ester, employing $Ti(OBu)_4$ as catalyst. The synthesized PBSPTES copolymers have been characterized from the molecular (NMR and GPC), thermal (TGA, DSC), structural (WAXS) and mechanical (tensile tests) point of view. Hydrolytic degradation has been also investigated under physiological conditions. Lastly, biocompatibility has been checked with H9c2 cells, derived from embryonic rat heart, employed as a cardiac muscle model.

Results and discussion

In all cases, the 1H -NMR spectra were found to be consistent with the expected structures and the actual molar composition was practically identical to the feed one. All the polymers had high and comparable molecular weight, proving that a good control of polymerization process was obtained.

The thermogravimetric data and the water contact angle measurements showed that all the samples were characterized by good thermal stability and by a surface hydrophilicity which increased with TES co-unit content, respectively. All copolymers were semicrystalline, with T_m and crystallinity degree decreasing with increasing TES unit content. Their mechanical properties as well as biodegradation rate were strictly related to crystallinity degree (χ_c), which decreased as the TES unit content was increased. Preliminary results with H9c2 cells demonstrated that PBS and PBSPTES copolymers were not cytotoxic and support cell proliferation.

Conclusions

The copolymer composition appeared to be the key parameter in determining the characteristics of the samples under investigation. The observed effects can all be ascribed to the ether-oxygen atoms present in the PEG-glycol subunit. In particular, this chemical modification induces an undoing of the ability to crystallize and an increase of wettability, improving copolymer biodegradability, a decrease of elastic modulus and an increase of elongation at break.

In conclusion, the physical properties of these novel materials, together with the encouraging cell culture results, suggest a high potential for their application in regenerative medicine of soft tissues, such as injured cardiac tissue, and its suitability for further studies in the case of mesenchyme-derived tissues.

References

- [1] A.W. Lloyd, *Med Device Technol*, 13, 18 (2002).
- [2] V. Tserki, P. Matzinos, E. Pavlidou et al., *Polym Degrad Stab*, 91, 367 (2006).
- [3] I. Vroman, L. Tighzert, *Materials*, 2, 307 (2009).

Studio di catalizzatori Fe/Mo nella sintesi dei nanotubi di carbonio multiparete

Carlo V. Mazzocchia¹, Attilio Citterio¹, Matteo A. Daghetta¹, Elena Iannicelli Zubiani¹, Lorenzo Pellegrino¹, Cristina Leonelli², Luca Pasquali²

¹Dipartimento di Chimica, Materiali e Ingegneria Chimica “Giulio Natta”, Politecnico di Milano, Piazza Leonardo da Vinci 32, 20133 Milano

²Dipartimento di Ingegneria “Enzo Ferrari”, Università di Modena e Reggio Emilia, Via Vignolese 905, 41125 Modena

Email: carlo.mazzocchia@polimi.it

ABSTRACT

Questo lavoro riguarda lo studio dell'attività di sistemi catalitici a base di ferro e molibdeno supportati su allumina, nella sintesi di nanotubi di carbonio (NTC) multi-parete. In particolare si porrà l'attenzione sul rapporto in peso Fe/Mo nella polvere catalitica e saranno valutate le prestazioni di vari catalizzatori in termini di resa, produttività, conversione e velocità di reazione.

Keywords: Nanotubi di carbonio, ferro, molibdeno, catalisi

L'interesse nei confronti dei nanotubi di carbonio è in continua crescita, come mostrano i dati sulle previsioni di mercato. Tale interesse è giustificato dal fatto che i nanotubi di carbonio mostrano molte caratteristiche, ad esempio proprietà elettriche, termiche, meccaniche, ottiche, ecc., che li rendono fra i materiali più promettenti della nuova era nanotecnologica [1]. A questo proposito, molti ricercatori sia del mondo dell'industria sia del mondo della ricerca, stanno lavorando per migliorare il prodotto, indirizzandolo ad applicazioni specifiche, e le condizioni di processo, in modo da abbattere i costi di produzione [2]. I nanotubi oggetto della presente indagine sono stati prodotti utilizzando la *Catalytic chemical vapour deposition*, in cui il carbonio gassoso si deposita su un solido (catalizzatore). La sintesi avviene in un reattore a letto fluido ($h = 100$ cm, $\varnothing = 15$ cm), mentre il catalizzatore è preparato secondo una procedura brevettata dal nostro gruppo di ricerca [3] ed è costituito da ossidi di ferro e molibdeno supportati su γ -allumina. Il reagente è etilene, che viene alimentato in una miscela di azoto e idrogeno. Come evidenziato in letteratura e come peraltro emerge dai nostri risultati, il molibdeno non presenta alcuna attività catalitica nella formazione dei nanotubi, tuttavia sembra esercitare un ruolo di promotore se aggiunto come additivo al ferro. Tale ruolo positivo è evidenziato dagli andamenti nel tempo della conversione per catalizzatori a diverso rapporto Fe:Mo (Figura 1). Una visione di insieme, per quanto riguarda la performance dei vari catalizzatori, è data dalla Figura 2, dalla quale è possibile evincere che all'aumentare del rapporto Fe:Mo migliorino le prestazioni, anche se per il caso 10:1 si ha un leggero calo, esclusa la selettività che sembra avere un trend opposto. Sia i catalizzatori sia i nanotubi prodotti sono stati caratterizzati tramite le tecniche XPS, XRPD, TGA, ICP-OES, SEM.



Figura 3: Andamento nel tempo della conversione di etilene per catalizzatori a differente rapporto Fe:Mo



Figura 2: Performance di diversi catalizzatori al variare del rapporto Fe:Mo

References

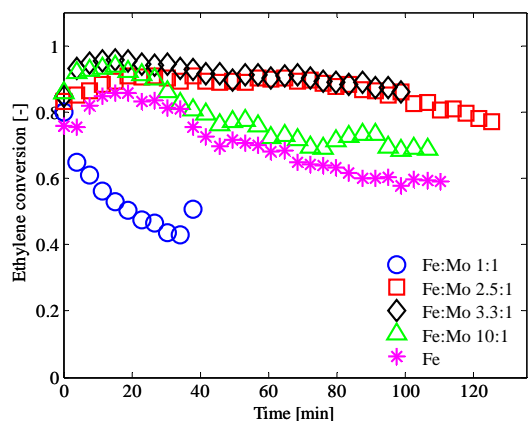
- [1] M.F. L. De Volder, S.H. Tawfick, R.H. Baughman, and A. J. Hart, *Science* 1, 339, 6119 (2013).
- [2] M. Daghetta, L. Pellegrino, A. Tito, C. Mazzocchia, and A. Citterio, *Proc. on NantechItaly 2012* (Venice, 2012) 10-NANOMAT, p. 254.
- [3] C. Mazzocchia, M. Bestetti, D. Acierno, and A. Tito, *Eur. Pat.* 2213369 (A1), (2010).

Thermodynamics of fluoride adsorption onto mesoporous alumina nanoparticles

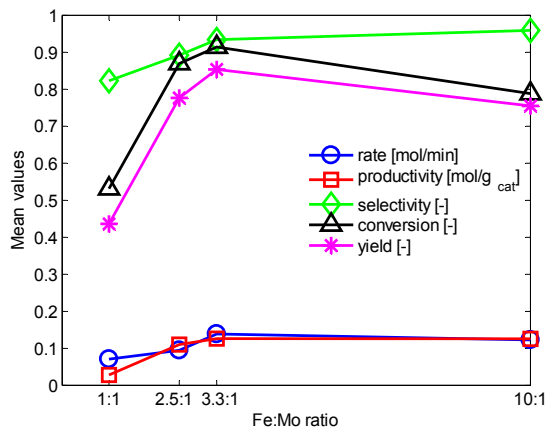
Andrea Melchior 1, Sara Gracia 1, Manuel Valiente 2, Marilena Tolazzi1

¹Dipartimento di Chimica Fisica e Ambiente, Università di Udine, Via del Cottonificio 108, 33100 Udine, Italy

²Departamento de Química, Centre GTS, Universitat Autònoma de Barcelona, Campus Bellaterra Edificio CN, Barcelona, Spain

Email: andrea.melchior@uniud.it

ABSTRACT

Fluoride contamination has been recognized as one of the most serious problems for water quality worldwide. Many methods exist to remove fluoride from water, but adsorption onto nanomaterials can offer several advantages over traditional methods. It is expected that nanomaterials will give better results than traditional sorbents in terms of higher loading capacity and lower residual concentration. Fluoride adsorption by alumina nanoparticles has been investigated in this work using a combined experimental approach which includes potentiometry and isothermal titration calorimetry (ITC).

Keywords: Fluoride, adsorption, isothermal titration calorimetry, alumina nanoparticles, water treatment

Fluoride is classified as one of the contaminants of water for human consumption by the World Health Organization (WHO) and it has been recognized as one of the main problems for water quality worldwide. Depending on the concentration and the consumption of water, the excess of fluoride can produce adverse effects for human health [1]. The WHO has established that acceptable F⁻ concentrations in water should be < 1.5 mg·L⁻¹.

Besides the natural geological sources, fluoride is released in water by many industries (ex. mining, metallurgy) which contribute to fluoride pollution. The effluents of these industries have fluoride concentrations extending from ten to thousands of mg·L⁻¹[1,2].

Nowadays many methods to remove fluoride from wastewater are available, such as adsorption [3-5], precipitation [6], electrocoagulation [7] or ion-exchange [8]. Adsorption shows considerable potential for fluoride removal from contaminated water [1-5], offering strategic advantages when compared to other techniques. However, the lowest limit achieved for fluoride removal with most adsorbents is greater than 2 mg·L⁻¹, therefore the improvement of effective adsorbents is of a great importance.

Inorganic metal oxides, organic adsorbents and other low cost materials have been proposed for fluoride removal[5]. Among these alumina is the most used because of its low cost and high affinity for fluoride [1,9], but its application is limited by the low adsorption capacity at neutral pH, poor adsorption kinetics and the difficulties of regeneration [5]. However, it has also been demonstrated that micro-particles of mesoporous alumina have high adsorption efficiency [5].

Nanomaterials can offer several advantages in waste water treatments over traditional methods, such as high surface area and short diffusion route. The high surface in relation to their volume are expected to give improved loading capacity, lower residual concentration, faster kinetics with the advantage of cost and materials savings.

The scope of this work is to study fluoride adsorption thermodynamics on high surface alumina nanoparticles (NP) and screen the synthesized materials to obtain an optimal candidate for the removal of fluoride from water.

Mesoporous alumina nanoparticles have been prepared and characterized by transmission electron microscopy (TEM), scanning electron microscopy (SEM) and BET. Adsorption studies have been carried out using a unique combined experimental approach which includes potentiometry (F-selective electrode) and, for the first time in this field, isothermal titration calorimetry (ITC). In our method, potentiometric data have been fitted with a Langmuir isotherm (eq. 1) to obtain the value of K_{ads} and loading capacity of the alumina NP (n).

$$[F^-]_{ads} = \frac{nK_{ads}[F^-]_e}{1 + K_{ads}[F^-]_e} \quad (1)$$

$[F^-]_e$ = equilibrium fluoride concentration (M), $[F^-]_{ads}$ = fluoride adsorbed at equilibrium (mol/g), n = maximum quantity of adsorbed F^- per gram of NP (mol/g) and K_{ads} = Langmuir constant (L/mol). Then, the K_{ads} and n have been used to calculate the free F^- concentration for each titrant addition in the calorimetric titrations (Fig.1). Finally, the ΔH_{ads} value has been calculated to best fit the experimental heat for the fluoride adsorption according to the modified isotherm (eq. 2).

$$q_{cum} = \frac{nK_{ads}[F^-]_e}{1 + K_{ads}[F^-]_e} \Delta H_{ads} \quad (2)$$

q_{cum} = total heat involved in the reaction per gram of adsorbent (J/g).

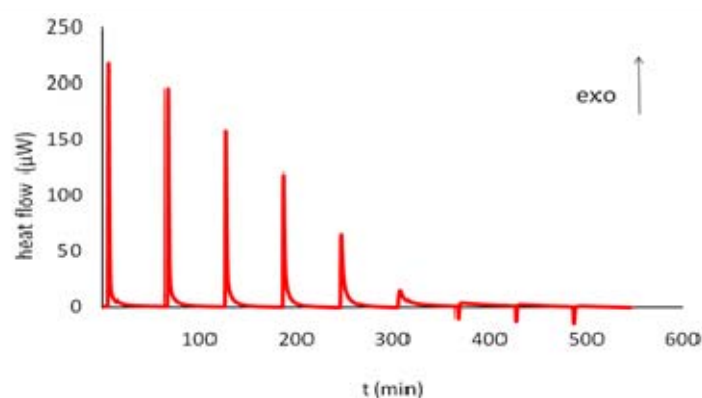

Figure 1: ITC for fluoride adsorption into mesoporous alumina NP. Each peak corresponds to an injection of 17,5µl of 80mM fluoride solution to 0.7mL of 0.5g·L⁻¹ alumina NP suspension.

References

- [1] A. Bhatnagar, E. Kumar, A. Sillanpa, *Chemical Engineering Journal*, 171(3), 811-840 (2011).
- [2] J. Fawell, K. Bailey, J. Chilton, E. Dahi, L. Fewtrell, Y. Magara, *Fluoride in Drinking-water*. World Health Organization (WHO) (2006).
- [3] W. Li, C. Y. Cao, L. Y. Wu, M. F. Ge, W. G. Song, *Journal of Hazardous Materials*, 198, 143-150 (2011).
- [4] X. L. Zhao, J. M. Wang, F. C. Wu, T. Wang, Y. Q. Cai, Y. L. Shi, G. B. Jiang, *Journal of Hazardous Materials*, 173(1-3), 102-109 (2010).
- [5] W. X. Gong, J. H. Qu, R. P. Liu, H. C. Lan, *Chemical Engineering Journal*, 189, 126-133 (2012).
- [6] E. J. Reardon, Y. X. Wang, *Environmental Science & Technology*, 34(15), 3247-3253 (2000).
- [7] M. Bennajah, B. Gourich, A. H. Essadki, C. Vial, H. Delmas, *Chemical Engineering Journal*, 148(1), 122-131 (2009).
- [8] C. Castel, M. Schweizer, M. O. Simonnot, M. Sardin, *Chemical Engineering Science*, 55(17), 3341-3352 (2000).
- [9] E. Kumar, A. Bhatnagar, U. Kumar, M. Sillanpaa, *Journal of Hazardous Materials*, 186(2-3), 1042-1049 (2011).

Green Nanocarriers for Epithelial Tumours Treatment

Ermelinda Bloise¹, Giuseppe Mele¹, Lucia Mergola¹, Barbara Piccinni², Alessandro Romano^{2,3}, Giuseppe Vasapollo¹, Tiziano Verri²

¹Department of Engineering for Innovation, University of Salento, via Arnesano, 73100 Lecce, Italy

²Department of Biological and Environmental Sciences and Technologies, University of Salento, via Monteroni, Lecce, Italy

³Neuropathology Unit, Institute of Experimental Neurology and Division of Neuroscience, IRCCS San Raffaele Scientific Institute, 20132, Milan, Italy.

Email: giuseppe.mele@unisalento.it

ABSTRACT

Nanotechnology has been utilized recently in medicine for the development of Drug Delivery Systems able to alter the kinetic profile of drug release that is very important in the administration of therapies for long periods as chemotherapy treatments, preventing damages to the normal surrounding tissue.

This work aims to test new types of engineered green nanocarriers produced by an environmental-friendly procedure for epithelial tumors treatment. Epithelial cancer is the largest single cause of death in both men and women, claiming over 6 million lives each year worldwide. For this reason, recently nanotechnology is attracting great interest in the search for new cancer therapies.

Keywords: epithelial tumor, cardanol, nanocarrier, lipophilic porphyrin

Recently new vesicular nanodispersions using Cashew Nut Shell Liquid (CNSL) components, such as cardanol, were made [1, 2]. Cardanol (CA), a natural and renewable organic raw material obtained as the major chemical component by vacuum distillation of CNSL, can be used for the preparation of fine chemicals and hybrid functional materials [3]. The antitumor activity of CNSL nanoemulsions on human MCF7 breast cancer has been recently demonstrated [4]. Moreover, a good antimicrobial activity of CA against gram positive [5, 6] and gram negative microorganisms [5] has been proved. For these peculiar properties two kinds of cardanol-based vesicular nanodispersions have been prepared and tested on different epithelial tumor cell lines.

In particular, a cardanol/cholesterol-based vesicular nanodispersion having an embedded lipophilic porphyrin itself peripherally functionalized with cardanol substituents (CA-CH-H₂Pp) and the corresponding blank sample containing only cardanol and cholesterol (CA-CH) see Figure 1. These vesicles have been characterized by TEM analysis (Figure 2).



Figure 1: Comparison of CA-CH-H₂Pp and CA-CH vesicular nanodispersions.

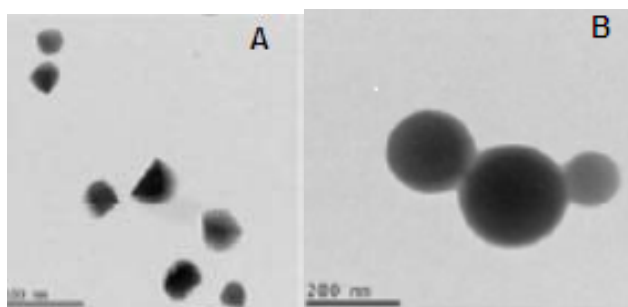

Figure 2: Transmission Electron micrographs of CA-CH (A) and CA-CH-H₂Pp (B)

These nanovesicles have been tested on culture cell lines to study their cytotoxicity effects. In particular, *in vitro* cytotoxicity of CA-CH-H₂Pp and CA-CH against 3T3 mouse fibroblast, NHDF1p8 normal human dermal fibroblast, human colon cancer CaCo2, breast cancer MCF7, and liver cancer HepG2 cells has been examined.

The exposure of cancer cells to vesicular nanodispersions (35-5 µg/µl; 1, 3, 6, 24, 48 hours) has resulted in a dose-dependent inhibition of cell growth determined by MTT (3-(4,5-dimethylthiazol-2-yl)-2,5-diphenyltetrazolium bromide) assay. Moreover, light microscopy examination of the cells exposed to each nanodispersion demonstrated significant changes in cellular morphology (Figure 3).

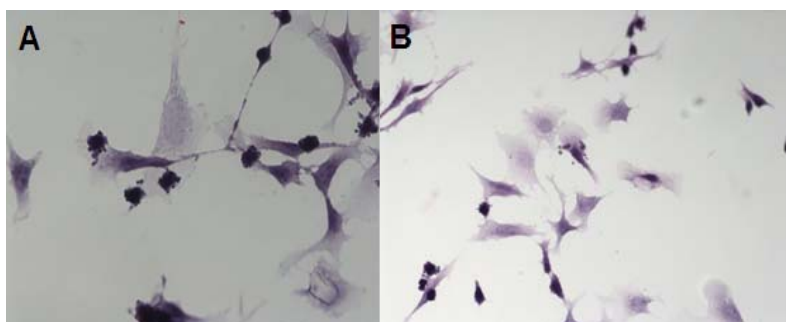

Figure 3: 3T3 cells after 1h of incubation with CA-CH (A) and CA-CH-H₂Pp vesicles (B) at 40X and 20X magnifications respectively.

References

- [1] E. Bloise, L. Carbone, G. Colafemmina, L. D'Accolti, S.E. Mazzetto, G. Vasapollo, G. Mele. *Molecules*, 17, 12252-12261 (2012).
- [2] E. Bloise; M. Becerra-Herrera; G. Mele; A. Sayago; L. Carbone; L. D'Accolti; S.E. Mazzetto; G. Vasapollo. *ACS Sustainable Chem. Eng.*, 2, 1299-1304 (2014).
- [3] G. Mele, G. Vasapollo, *Mini Rev. Org. Chem.*, 5, 243-253 (2008).
- [4] A. Al-Hazzani, V. Periyasamy, P. Subash-Babu, A. A. Alshatwi. *Med Chem Res* 21, 1384-1388 (2012).
- [5] P. Boonsai, P. Phuwapraisirisan, C. Chanchao. *Int. J. Med. Sci.* 11, 327-336 (2014).
- [6] C. Celis, A. García, G. Sequeda, G. Mendez, R. Torrenegra. *Emir. J. Food Agric.* 23, 249-257 (2011).

Biomimetic Polyurethane Scaffolds for Myocardial Tissue Engineering

Pamela Mozetic¹, Valeria Chiono², Antonella Silvestri², Monica Boffito², Emilia Gioffredi², Susanna Sartori², Sara Maria Giannitelli¹, Alberto Rainer¹, Daria Anna Nurzynska³, Clotilde Castaldo³, Franca Di Meglio³, Gianluca Ciardelli² and Marcella Trombetta¹

¹ Center for Integrated Research, “Università Campus Bio-Medico di Roma”, via Alvaro del Portillo 21, 00128 Roma, Italy

² Department of Mechanical and Aerospace Engineering, Politecnico di Torino, C.so Duca degli Abruzzi 24, 10129 Turin, Italy

³ Department of Public Health, University of Naples “Federico II”, via S.Pansini 5, 80131 Naples, Italy.

Email: m.trombetta@unicampus.it

ABSTRACT

The recent trend of Tissue Engineering (TE) is the use of degradable biomimetic tissue-specific materials, providing appropriate chemical and biological cues that mimic the native microenvironment. In the field of myocardial regeneration, a promising approach is to engineer scaffolds modulating cell response in a similar manner as niches found in vivo. Segmented polyurethanes are attractive for myocardial TE, being elastomeric biomaterials with tunable physicochemical properties and good biocompatibility. In this work, an elastomeric polyurethane was synthesized for the preparation of scaffolds for myocardial tissue engineering [1].

Keywords: Polyurethane, Scaffold, Additive manufacturing, Myocardial tissue engineering

A biocompatible polyurethane (PU) was synthesized from poly(ϵ -caprolactone) diol ($M_n=2000$ g/mol), 1,4-butane diisocyanate and lysine ethyl ester. The synthesized biomaterial was characterized in terms of mechanical, rheological and thermal properties.

3D PU scaffolds with a 0/90° lay-down pattern were fabricated by melt-extrusion additive manufacturing process. Scaffolds showed an elastomeric-like behavior, which is promising for applications in myocardial regeneration.

PU scaffolds supported the adhesion and spreading of human cardiac progenitor cells (hCPCs), whereas they did not stimulate hCPC proliferation after 14 days culture time.

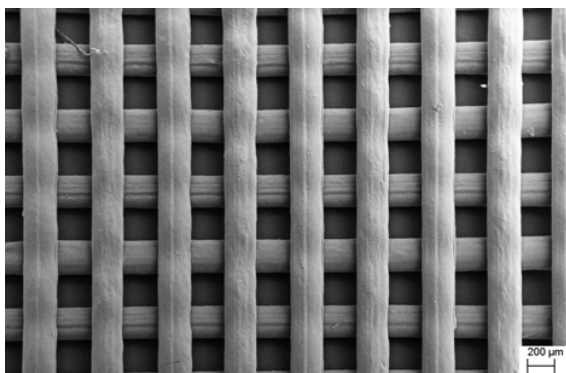

Figure 1: FE-SEM micrograph of the PU scaffold

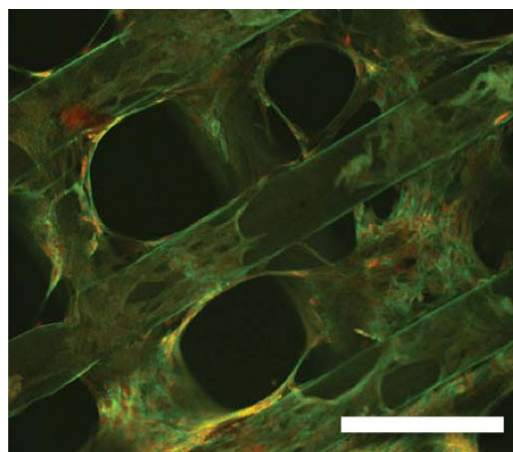

Figure 2: Confocal micrograph of hCPCs seeded on the scaffold. Green: actin; red: nuclei. Scale bar: 200 μ m.

References

[1] V.Chiono, P.Mozetic, M.Boffito, S.Sartori et al. *Interface Focus*, 4, 20130045, (2014)

Synthesis and Coordination Reactions of the Ketenylidene $\text{Ph}_2\text{P}(\text{CH}_2)_2(\text{Ph})_2\text{P}=\text{C}=\text{C}=\text{O}$ to Rhodium Complexes

Mirto Mozzon¹, Giacomo Facchin², Augusto Tassan¹

¹Dipartimento di Ingegneria Industriale, Università di Padova, Via Marzolo 9, Padova 35131, Italy

²Istituto per l'Energetica e le Interfasi IENI-CNR, Via Marzolo 9, Padova 35131, Italy

Email: mirto.mozzon@unipd.it

ABSTRACT

We report herein the reaction of $[\text{Ph}_2\text{P}(\text{CH}_2)_2(\text{Ph})_2\text{P}=\text{C}=\text{C}=\text{O}]$ functionalized with a free phosphine group towards metal substrates.

Keywords: Ketenylidene, rhodium, ylide

The chemistry of ketenylidenetriphenylphosphorane $[\text{Ph}_3\text{P}=\text{C}=\text{C}=\text{O}]$ towards metal substrates gives complexes in which the ylide is σ -bonded to the metal through the ylidic carbon atom [1]. With the aim to study in depth the chemistry of ketenylidenetriphenylphosphorane, we have investigated the reaction of $[\text{Ph}_2\text{P}(\text{CH}_2)_2(\text{Ph})_2\text{P}=\text{C}=\text{C}=\text{O}]$ functionalized with a free phosphine group towards metal substrates. In particular, we carried out the coordination of the $(\text{Ph})_2\text{P}(\text{CH}_2)_2(\text{Ph})_2\text{P}=\text{C}=\text{C}=\text{O}$ over the rhodium complex $[\textit{trans}\text{-RhCl}(\text{CO})(\text{PPh}_3)_2]$.

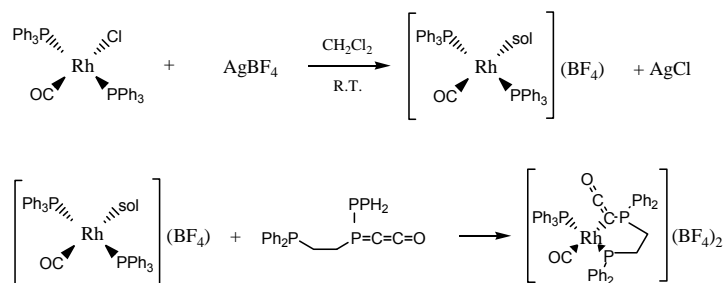

Scheme 1

The reaction of ylide with rhodium leads to the formation of a derivative that, according to spectroscopic data, shows a structure in which the chelated ylide is bonded to the metal through the carbon ylidic and phosphine functionalities (as already reported for the platinum complex) [2]. In the carbonyl area of the IR spectrum there are two bands: one at 2004 cm^{-1} accounting for the carbonyl directly bound to the rhodium atom, and another at 2076 cm^{-1} typical of a ketenilic group coordinated to a metal centre. The $^{31}\text{P}\{^1\text{H}\}$ -NMR spectrum indicates the presence of only one compound and shows three sets of signals. The first set is made of two doublets of doublets assigned to the coordinated phosphine at 30.6 ppm ($^1J_{\text{PRh}} = 121.5\text{ Hz}$, $^2J_{\text{PP}} = 320\text{ Hz}$). The ylidic ligand shows a signal at 18.2 ppm , with $^1J_{\text{PRh}} = 121.5\text{ Hz}$ and $^2J_{\text{PP}} = 23.6\text{ Hz}$ (with the phosphonium group). The chemical shift of the phosphonium system is at 25.1 ppm and

AICIng IX

appears as a broadened doublet with ${}^3J_{\text{pp}} = 23.6$ Hz (with the other ylidic phosphorus). The ${}^{13}\text{C}\{^1\text{H}\}$ -NMR spectrum exhibits a signal at 163.20 ppm which can be assigned to the carbonyl carbon of ketenilic group.

The IR spectrum of the same reaction reported in Scheme 1 but using *trans*-[Rh(CO)(PCy₃)₂(Cl)] as starting material shows two IR bands at 1961 and 1940 cm⁻¹ (CO coordinated to the metal) and one at 2077 cm⁻¹, typical of the coordinated ketenilic ylide. On the contrary, the ${}^{31}\text{P}\{^1\text{H}\}$ -NMR shows the presence of more products. In this case it is likely that the steric hindrance of the PCy₃ ligand modifies the system reactivity, as observed for the reaction of *trans*-{Pt(CH₃)(PCy₃)₂[CNC₆H₄-o-CH₂PMe₃](BF₄)₂} with a NEt₃ excess [3].

References

- [1] L. Pandolfo, G. Paiaro, L. K. Dragani, C. Maccato, R. Bertani, G. Facchin, L. Zanotto, P. Ganis, G. Valle, *Organometallics* 15, 3250, (1996).
- [2] S. Mazzega Sbovata, A. Tassan, G. Facchin, *Inorganica Chimica Acta* 361, 3177, (2008).
- [3] R.A. Michelin, G. Facchin, D. Braga, P. Sabatino, *Organometallics*, 5, 2265, (1986).

The intramolecular dynamic study of cluster $[\text{Ir}_4(\text{CO})_{10}(\text{bis}(\text{diphenylarsino})\text{-methane})]$ by NMR spectroscopy

Mirto Mozzon¹, Giacomo Facchin², Augusto Tassan¹

¹Dipartimento di Ingegneria Industriale, Università di Padova, Via Marzolo 9, Padova 35131, Italy

²Istituto per l'Energetica e le Interfasi IENI-CNR, Via Marzolo 9, Padova 35131, Italy

Email: mirto.mozzon@unipd.it

ABSTRACT

We report herein the intramolecular dynamic study of iridium dodecacarbonyl derivatives with bis(diphenylarsino)-methane (1) and (diphenylphosphine)-methane (2) carried out by ¹H NMR spectroscopy.

Keyword: iridium dodecacarbonyl, cluster, arsine, NMR

Intramolecular dynamics of carbonyls (merry-go-round, face changing and rotation of apical CO's) of $[\text{Ir}_4(\text{CO})_{12}]$ disubstituted derivatives have been extensively studied [1]. The clusters (1) and (2) (see Scheme 1) have been prepared according to known literature data [2].

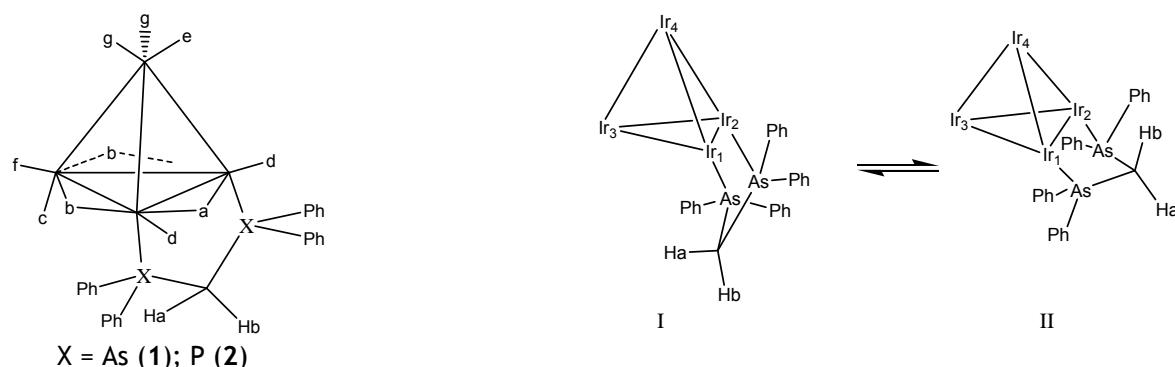

We have carried out a series of NMR analyses by collecting ¹H spectra from 250 K to 180 K for (1) and (2) (Figure 1). At 180 K, the axial protons Ha and Hb show peaks at 2.68 and 3.82 ppm, respectively, with a coupling constant of 13.1 Hz. Hence the two protons are not equivalent; Ha is placed equatorial under the basal face triangle, while Hb is axial and it is not affected by the ring current generated by Ir1-Ir2-Ir3 triangle. Raising the temperature to 190 and further to 200 K there is an approachment of the two sets of the signal and an enlargement at half width of Ha (broadening) while the proton Hb keeps visible the doublet with the same coupling constant.

At about 220 K, the position of two signals is inverted: the peaks of proton Ha shift at higher field with respect to the broad signal of the Hb proton. Raising the temperature to 230 and further to 250 K is visible an enlargement of two sets of signals.

This trend can be explained with two different envelope configurations of the five atoms ring (Ir-As-CH₂-As-Ir), as shown in Scheme 2; in structure I, the proton Ha is located below the basal triangle formed by Ir1-Ir2-Ir3; when temperature is raised, it reverses its conformation from equatorial to axial, as depicted in structure II. Conversely, the proton Hb is in equatorial position and affected by ring current of Ir1-Ir2-Ir4.

A similar analysis performed at 173 K on compound (2) does not show reversal (in, out) of the two protons Ha and Hb. This is probably due to the smaller atomic radius of the phosphorous atom with respect to the arsenic atom, with a stronger bond to the metal core.

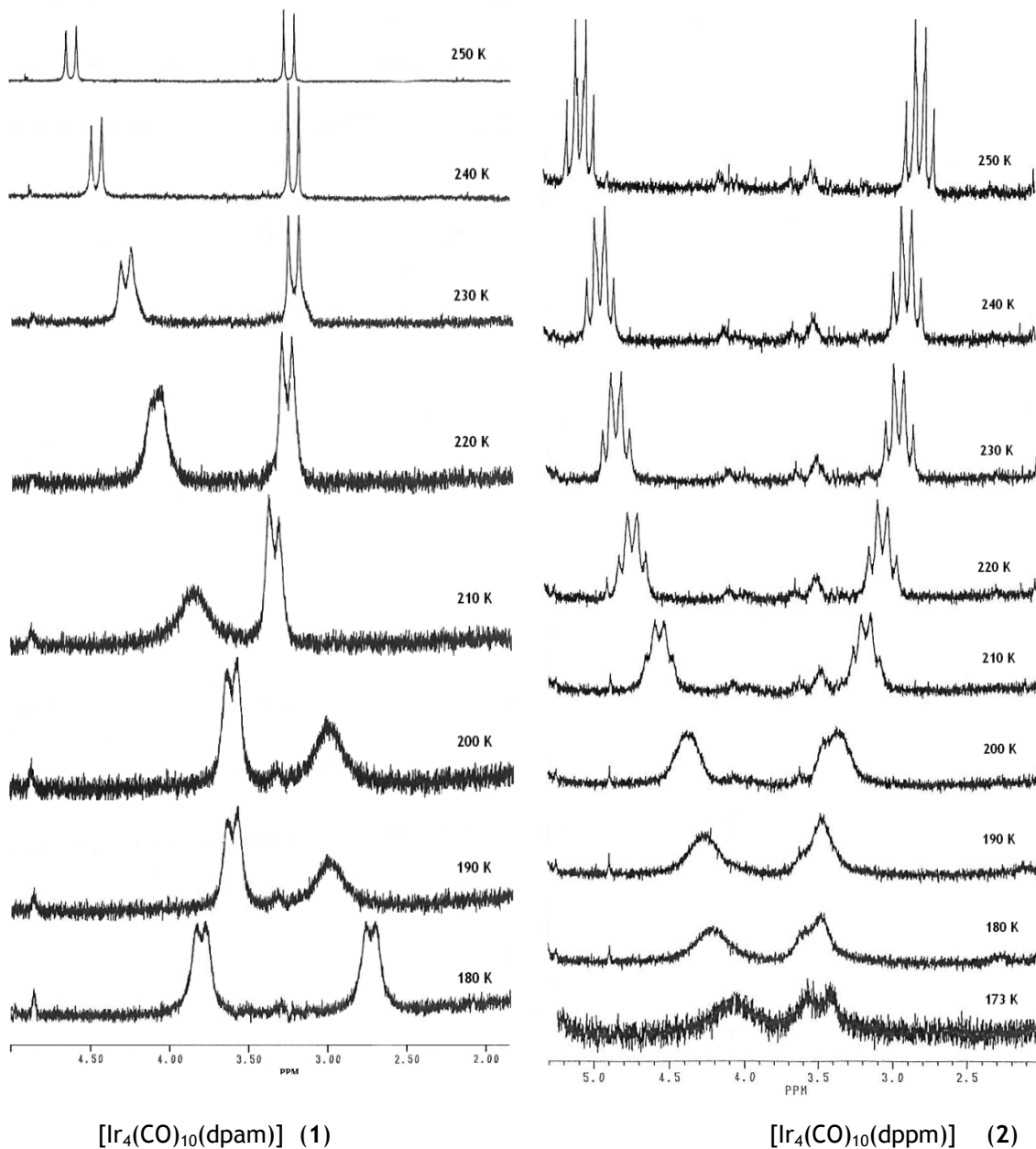

Figure 1. Temperature dependence of the protons Ha and Hb spectra for (1) and (2) in CD_2Cl_2 .

References

- [1] (a) A. Orlandi, R. Ros, R. Roulet, *Helvetica Chimica Acta*, 74 (1991) 1464. (b) T. Lumini, G. Laurenczy, R. Roulet, A. Tassan, R. Ros, K. Schenk, *Helvetica Chimica Acta*, 81 (1998) 781.
- [2] A. Stawcynski, G. Suardi, R. Ros, R. Roulet, *Helvetica Chimica Acta*, 76 (1993) 2210.

Electro-Fenton Degradation of Anionic Surfactants

M. Panizza, A. Barbucci, M.P. Carpanese, S. Congiu, M. Delucchi, A. Giuliano, G. Cerisola.

Department of Civil, Chemical and Environmental Engineering, University of Genoa, P.le Kennedy 1, 16129 Genoa, Italy

Email: marco.panizza@unige.it

ABSTRACT

The degradation of sodium dodecyl benzene sulfonate (LAS), a common industrial and household anionic surfactant, has been investigated by electro-Fenton process. The electrolyses have been performed using an undivided cell equipped with a Ti/RuO₂ anode and a commercial graphite-felt to electrogenerate in situ hydrogen peroxide and regenerate ferrous ions as catalyst. The effect of operating conditions such as applied current, catalyst concentration and initial pH has been studied. The experimental results showed that LAS was completely removed by the reaction with [•]OH radicals generated from electrochemically assisted Fenton's reaction, and the decay kinetic always follows a pseudo-first-order reaction. The optimum experimental conditions has been obtained at I=200 MA, pH 3 and in the presence of 0.3 mM Fe²⁺ as catalyst.

Keywords: Anionic surfactant, Electro-Fenton, Carbon felt, Hydroxyl radicals

The continuous increase in the consumption of synthetic detergents in laundry, household, carwash and textile washing constitutes a very important environmental concern. In fact, even if they are easily biodegradable, their presence in water favour the formation of stable and difficult-to-separate emulsion and anomalies in the growth of algae. For these reasons it would be desirable to remove surfactants prior to the discharge of washing waters. Different processes have been described for the treatment of surfactants, such as coagulation, microwave irradiation and Advanced Oxidation Processes.

Among the AOPs, the electro-Fenton (EF) is a promising alternative for the treatment of wastewaters because it is environmentally clean and can produce large amount of hydroxyl radicals under control of applied current. In the EF the [•]OH are produced in the bulk of the polluted solution using the electrogenerated Fenton's reagent (eq. 1) where H₂O₂ is supplied in situ from the two-electron reduction of O₂ (Eq. 2) and Fe²⁺ is continually regenerated from Fe³⁺ reduction (eq. 3):

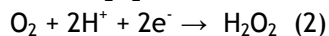
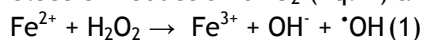

In this study, the degradation of sodium dodecyl benzene sulfonate (LAS), a common industrial and household anionic surfactant, has been investigated by electro-Fenton process at constant current. The electrolyses have been performed using an undivided cell equipped with a Ti/RuO₂ anode and a commercial graphite-felt to electrogenerate in situ hydrogen peroxide and regenerate ferrous ions as catalyst. The effect of operating conditions such as applied current, catalyst concentration, initial surfactant concentration and initial pH has been studied. Surfactant decay kinetic was monitored during the electrolysis by UV-vis measurements.

In the electro-Fenton process the applied current is an important parameter for the operational cost and process efficiency, because both the production rate of H₂O₂ and the regeneration of Fe²⁺ is affected by the applied current. The effect of this parameter on the decay kinetics of LAS was investigated by conducting constant current electrolysis at different current values, i.e., 50, 100, 200, and 300 mA in the presence of 0.3 mM of Fe²⁺ as catalyst and pH=3. Figure 1 shows that for all the applied current LAS was completely degraded by the reaction with [•]OH radicals and the

degradation rate increased with applied current. This faster oxidation rate at higher current could be ascribed to acceleration of H_2O_2 formation rate according to reaction (2) leading to the generation of higher amount of hydroxyl radicals from Fenton's reaction (Eq. 3).

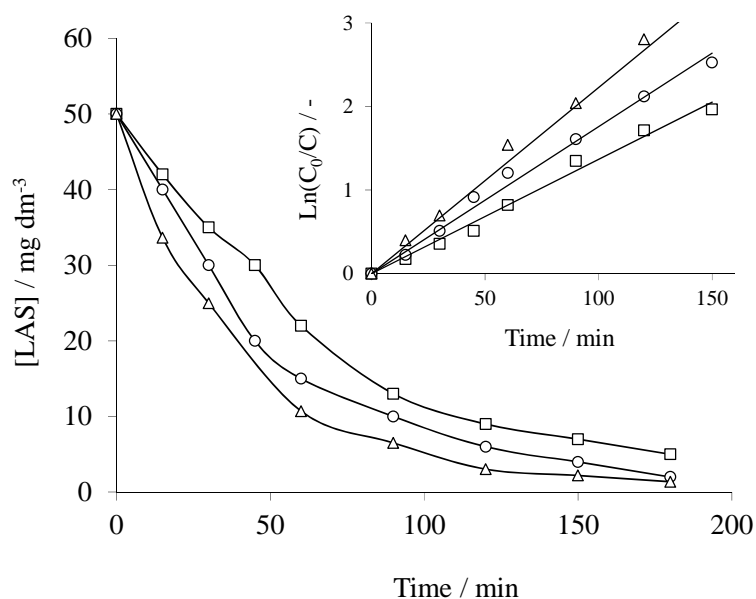

Figure. 1 Effect of applied current on the evolution of LAS concentration during the electrolysis of 50 mg dm^{-3} at applied current: (\square) 100 mA; (\circ) 150 mA and (Δ) 200 mA. Conditions: $\text{pH} = 3$; $[\text{Fe}^{2+}] = 0.3 \text{ mM}$. The inset presents the corresponding kinetics analysis assuming a pseudo first-order reaction.

The Fe^{2+} concentration and solution pH are other important parameters in the electro-Fenton process. In an attempt to optimise reaction conditions on the EF system, degradation of 50 mg dm^{-3} LAS was investigated in the presence of different Fe^{2+} concentrations and different pH applying a constant current of 200 mA. With our cell design, the higher oxidation rate has been obtained at pH 3 and in the presence of 0.3 mM Fe^{2+} as catalyst. In these conditions, after 180 min of electrolysis almost complete oxidation of 50 mg dm^{-3} of LAS has been obtained with a specific energy consumption of $9.53 \pm 0.5 \text{ kW h m}^{-3}$.

TiO₂-induced photoisomerization of caffeic acid

F. Parrino¹, E. Garcia-Lopez¹, V. Loddo¹, I. Pibiri², M. Bellardita¹, A. Di Paola¹, L. Palmisano¹

¹ Dipartimento DEIM, Università di Palermo, Viale delle Scienze Ed. 6, 90128, Palermo, Italia

² Dipartimento STEBICEF, Università di Palermo, Viale delle Scienze Ed. 16, 90128, Palermo, Italia

marianna.bellardita@unipa.it

ABSTRACT

In this work we report the isomerization of trans-caffeic to cis-caffeic acid under UV light irradiation in the presence of different TiO₂ photocatalysts at different pH values.

Keywords: photoisomerization, caffeic acid, titanium dioxide

Caffeic acid is an organic compound naturally present in plant kingdom belonging to hydroxycinnamic acid. The light induced isomerization of these family of acid is known in the literature[1] but it has not been studied in the presence of a catalyst. In this work we investigate the extent of the photoisomerization of trans-caffeic acid both in absence and in presence of various titanium dioxide powders at different pH values (3.5, 6 and 8) in order to understand the role of the catalyst and the mechanism of the process. The runs were carried out in a cylindrical photoreactor irradiated by fluorescent lamps whose main emission peak was in the near-UV region at 365 nm by bubbling nitrogen. Two commercial TiO₂ samples (Degussa P25 and Merck) and a home-prepared TiO₂ sample (HP0.5) were used as catalysts. The photoisomerization (Figure 1) proceeded until a photo-stationary state was reached and a constant value of the cis/trans ratio was obtained. In all cases the higher degree of isomerization was observed for higher pH values. The cis/trans ratio found in homogeneous phase was 1.8. This value decreased to 1.6 in the presence of Merck and reached 2.0 and 2.2 in the presence of P25 and HP05 respectively. This finding indicates that the isomerization of trans-caffeic to cis-caffeic acid was influenced by the presence of the photo-catalyst. In particular Merck was slightly detrimental while P25 and HP05 favored the isomerization. The reason of this different behavior can be attributed to the low adsorption ability of Merck with respect to P25 and HP05 samples.

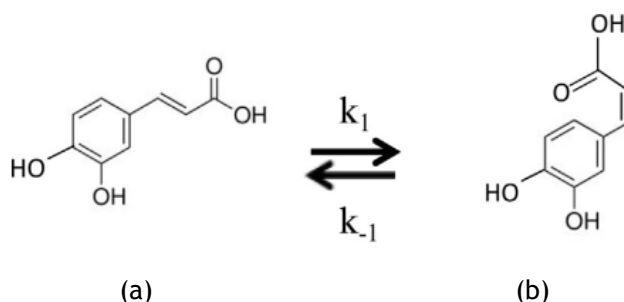

Figure 1: Trans-caffeic (a) and cis-caffeic (b) acid.

References

- [1] A. Le Person, A.S. Lacoste, J.P. Cornard, *Journal of Photochemistry and Photobiology A: Chemistry*, 265, 10-19, (2013).

Nanospugne di ciclodestrine: uno studio di dinamica molecolare

Giuseppina Raffaini, Andrea Mele, Franca Castiglione, Fabio Ganazzoli

Dipartimento di Chimica, Materiali e Ingegneria Chimica 'G. Natta', Politecnico di Milano,
via Mancinelli 7, 20131 Milano

Email: giuseppina.raffaini@polimi.it, fabio.ganazzoli@polimi.it

ABSTRACT

Simulazioni atomistiche di dinamica molecolare sono state utilizzate per studiare l'idratazione e la diffusione delle molecole d'acqua in una nanospugna di ciclodestrine, un polimero altamente reticolato estremamente versatile ed efficiente nella formazione di complessi di inclusione con diversi tipi di molecole ospiti.

Keywords: Simulazioni, dinamica molecolare, ciclodestrine, nanospugne

Le nanospugne di ciclodestrine (CD-NS) sono nuovi polimeri reticolati ottenuti dalla reazione di β -ciclodestrine (β -CD) con opportuni agenti reticolanti come anidridi o carbonati organici [1-3]. Questi materiali si sono mostrati molto versatili per complessare una gran varietà di molecole, mostrandosi per esempio molto efficienti nel campo del rilascio controllato di farmaci e nella rimozione di agenti inquinanti. Infatti, le CD-NS hanno una struttura tridimensionale con una densità variabile di reticolazione, e sono caratterizzati dalla presenza di canali e cavità di dimensioni nanometriche che permettono di incapsulare molecole ospiti, compresa l'acqua, nel reticolo polimerico.

La modellazione atomistica con metodi di meccanica e di dinamica molecolare si è dimostrata molto utile nella descrizione di fenomeni importanti in cui le interazioni non covalenti sono il fattore dominante, come per esempio nella formazione di complessi di inclusione delle ciclodestrine [4-6] e nell'adsorbimento di proteine su biomateriali e nanomateriali [7]. In questo lavoro, questi metodi sono utilizzati per studiare le proprietà conformazionali delle CD-NS, sia in acqua sia in vuoto. In particolare, si descrive il rigonfiamento di questi sistemi in acqua, l'idratazione complessiva e la mobilità dell'acqua all'interno ed alla superficie delle CD-NS [8]. In questo modo, si discuteranno i coefficienti di diffusione calcolati per molecole d'acqua "libere" e "legate" all'interno delle cavità della CD-NS, e la presenza di molecole d'acqua legate solo temporaneamente alla superficie del sistema.

References

- [1] D. Li, M. Ma, *Chem. Mater.* 11, 872-874 (1999)
- [2] F. Trotta, W. Tumiatti, Patent WO 03/085002 (2003)
- [3] A. Mele, F. Castiglione, L. Malpezzi, F. Ganazzoli, G. Raffaini, F. Trotta, B. Rossi, A. Fontana, G. Giunchi, *J. Incl. Phenom. Macrocycl. Chem.* 69, 403-409 (2011)
- [4] G. Raffaini, F. Ganazzoli, L. Malpezzi, C. Fuganti, G. Fronza, W. Panzeri, A. Mele, *J. Phys. Chem. B*, 113, 9110-9122 (2009).
- [5] G. Raffaini, F. Ganazzoli, *J. Phys. Chem. B*, 114, 7133-7139 (2010).
- [6] G. Raffaini, F. Ganazzoli, *Chem. Phys.*, 333, 128-134 (2007).
- [7] G. Raffaini, F. Ganazzoli, *Macromol. Biosci.*, 7, 552-566 (2007).
- [8] G. Raffaini, F. Ganazzoli, A. Mele, F. Castiglione, *J. Incl. Phenom. Macrocycl. Chem.* 75, 263-268 (2013).

Nickel-Titania Catalysts For Ethanol Steam Reforming.

Gianguido Ramis¹, Ilenia Rossetti², Elisabetta Finocchio¹,

¹ Dip. Ingegneria Civile, Chimica e Ambientale, P.le J.F.Kennedy 1, Università di Genova, 16129 Genova, Italy.

² Dip. Chimica, Università degli Studi di Milano, CNR-ISTM and INSTM Unit - Milano Università, via C. Golgi 19, I-20133 Milano, Italy

Email: gianguidoramis@unige.it

ABSTRACT

Ni/TiO₂ catalysts for steam reforming of ethanol were prepared by Flame Pyrolysis. The catalytic performances, in terms of both H₂ productivity and stability towards coking and sintering, were related to the physico-chemical properties of the catalysts. Physico-chemical properties of both the fresh and spent catalysts have been compared.

Keywords: Hydrogen; Coke; Nickel-Titania

Ni-Titania catalysts have been prepared by Flame Pyrolysis (FP) for use in the steam reforming of ethanol. The FP technique has been adopted here to check the effect of this innovative preparation procedure on Ni dispersion and strength of interaction with the support and on catalyst performance for ESR reaction. The FP sample was synthesised using a solution of Titanium(IV)-isopropylate as reported in ref. 1.

TPR-TPO cycles confirm that Ni is initially well dispersed in the support and, after a first reduction process, may arrange in clusters, likely characterised by a different reducibility in a wide temperature range (300-700°C). Such species can be described as arising from reduction of free surface NiO, bulk NiO and NiO deeply interacting with the TiO₂ surface as well as to NiTiO₃.

Low temperature CO adsorption gives rise to several IR bands in the carbonyl spectral region. The absorption at 2184 cm⁻¹ characterizes surface Ti⁴⁺ acting as Lewis sites of different strength. Another weak component at 2139 cm⁻¹, with the shoulder at 2090 cm⁻¹, indicates the presence of gem dicarbonyls species over dispersed Ni⁺ ions. In the region 2000-2100 cm⁻¹ several bands associated with CO linearly adsorbed on NiO small crystals (main band at 2061 cm⁻¹), but also to polycarbonyl species, unstable after outgassing. An additional broad and weak band is centred at 1989 cm⁻¹ corresponds to bridging CO over more structured Ni metal particles. Thus Ni is broadly reduced at the catalyst surface, although highly dispersed. On the other side, the heterogeneity of the Ni species is in agreement with TPR results, pointing out the presence of Ni metal particles, Ni metal clusters strongly interacting with the support and Ni ions having different reducibility. Nitrides adsorption evidenced medium strength Lewis acid sites.

Activity test at atmospheric pressure and in the range 500-750°C were performed by feeding 3:1 (mol/mol) H₂O:CH₃CH₂OH liquid mixture in He/N₂ (GHSV = 1750 h⁻¹ referred to the ethanol + water gaseous mixture). The sample showed stable at 750°C with good C balance, full ethanol conversion, no by-products and high hydrogen productivity. At low temperature (500°C) extensive deactivation process occurred, likely due to reversible coking, as testified by the good performance during the subsequent testing at 625°C. These confirms point out high Ni dispersion.

According to the present results, FP catalyst is an interesting candidate for ESR at 625°C.

References

[1] I.,Rossetti, J. Lasso, E. Finocchio, G. Ramis, V. Nichele, M. Signoretto, A. Di Michele, *Applied catalysis A: General*, in press.

Sintesi per combustione di ossidi misti: sintesi convenzionale ed assistita da microonde

Roberto Rosa¹, Valeria Felice², Chiara Ponzoni¹, Isabella Natali-Sora², Francesca Fontana², Cristina Leonelli¹

¹Dipartimento di Ingegneria "Enzo Ferrari", Università di Modena e Reggio Emilia, Via Vignolese 905, 41125 Modena, Italy

²Dipartimento di Ingegneria, Università di Bergamo, Viale Marconi 5, 24044 Dalmine (BG), Italy

Email: isabella.natali-sora@unibg.it

ABSTRACT

Tra gli ossidi misti, ed in particolare le perovskiti, trovano un ruolo di particolare interesse le ferriti di lantanio di formula generale $(La_{1-x}Sr_xFe_{1-y}Cu_yO_{3-w})$ con $x= 0-0.4$ e $y= 0-0.4$ impiegati come materiali catodici in celle a combustibile ad ossido solido (SOFCs). Poiché le proprietà di questi composti dipendono fortemente dalla forma e dalle dimensioni dei cristalliti primari e secondari, si sono voluti studiare due metodi di sintesi che presentino un basso impatto ambientale [1]. Si tratta della sintesi per autocombustione da soluzione (SCS) a partire da nitrati come precursori in presenza di acido citrico (utilizzando acqua come solvente) e successiva calcinazione a 600°C. Tale procedura di sintesi è assai meno impattante in termini di tempi ed energia rispetto alle più utilizzate sintesi idrotermali. Il secondo metodo equivale al primo, trattandosi sempre di SCS, ma prevede un'attivazione attraverso l'irraggiamento di microonde.

La presenza di composti identificati come combustibili nella miscela dei materiali di partenza permette alla combustione di procedere grazie al solo calore della reazione esotermica limitando alla sola fase di innesco l'energia da fornire. Nel caso dell'irraggiamento con microonde è, invece, possibile procedere con il trasferimento di energia elettromagnetica all'ambiente caldo della reazione esplosiva SCS anche quando questa ha già preso avvio, dando luogo a condizioni uniche ed estreme [2].

Nel lavoro vengono messe a confronto le perovskiti diversamente drogate: $LaFeO_3$ (LF), $LaFe_{0.8}Cu_{0.2}O_{3-w}$ (LFC20), $La_{0.8}Sr_{0.2}FeO_{3-w}$ (LSF20) e $La_{0.8}Sr_{0.2}Fe_{0.8}Cu_{0.2}O_{3-w}$ (LSFC2020) ottenute per SCS di geli. Le dimensioni granulometriche, contenute sotto ai 70 nm, e le fasi cristalline dipendono non solo dal metodo di sintesi, ma anche dal drogaggio (Figura 1).



Figura 1: Dimensioni dei cristalliti in funzione del drogaggio e della via sintetica seguita.

Keywords: perovskiti, sintesi per combustione, microonde, morfologia.

References

- [1] I. Natali Sora, T. Caronna, F. Fontana, C. de Julian Fernandez, A. Caneschi, M. Green, Crystal structure and magnetic properties of strontium and copper doped lanthanum ferrites, *J. Solid State Chem.* 191, 2012, 33-39.
- [2] R. Rosa, P. Veronesi, C. Leonelli, A review on combustion synthesis intensification by means of microwave energy, *Chemical Engineering and Processing* 71, 2013, 2-18.

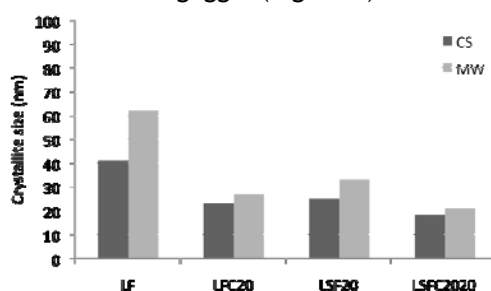
Compositi geopolimerici contenenti resine melamminiche resistenti al fuoco

Giuseppina Roviello^a, Laura Ricciotti^a, Claudio Ferone^a, Francesco Colangelo^a, Raffaele Cioffi^a, Oreste Tarallo^b

^a *Dipartimento di Ingegneria, Università di Napoli 'Parthenope', INSTM Research Group Napoli Parthenope, Centro Direzionale Napoli, Isola C4, 80143 Napoli, Italy.*

^b *Dipartimento di Scienze Chimiche, Università degli Studi di Napoli "Federico II", Complesso Universitario di Monte S. Angelo, via Cintia, 80126 Napoli, Italy.*

E-mail: giuseppina.roviello@uniparthenope.it

ABSTRACT

Nuovi materiali compositi basati su geopolimeri, contenenti resine melamminiche sono stati preparati mediante un approccio sintetico basato sulla co-reticolazione in condizioni blande della fase organica ed inorganica. I materiali ottenuti mostrano migliorate proprietà meccaniche rispetto al geopolimero puro e nonostante includano fino al 25% in peso di resina, non sono infiammabili e non producono fumi.

Keywords: geopolimeri, resine melamminiche, ibridi compositi, resistenza al fuoco, proprietà meccaniche.

Nuovi materiali ibridi geopolimerici, contenenti resine epossidiche a base di melammina, sono stati progettati in modo da realizzare un'alta compatibilità tra la fase organica ed inorganica. Questo obiettivo è stato perseguito utilizzando un metodo di sintesi basato sulla co-reticolazione in condizioni blande delle due fasi, messo a punto di recente dagli autori [1,2]. I nuovi materiali mostrano: una buona compenetrazione della resina nella matrice inorganica fino a livello nanometrico per semplice miscelazione meccanica; proprietà meccaniche significativamente migliorate rispetto al geopolimero non modificato; buona stabilità termica e resistenza al fuoco. Queste caratteristiche rendono i nuovi materiali molto attraenti per la realizzazione di pannelli termoisolanti e termoresistenti in quanto i) sono 'Environmental Friendly' essendo basati su materiali geopolimerici che, come è noto [3,4] hanno un impatto ambientale inferiore rispetto al Cemento Portland Ordinario; ii) hanno buone prestazioni meccaniche grazie alla presenza di una fase organica strettamente interpenetrata, che riduce significativamente la fragilità della matrice geopolimerica; iii) non sono infiammabili, anche se contenenti fino al 25% in peso di resina organica.

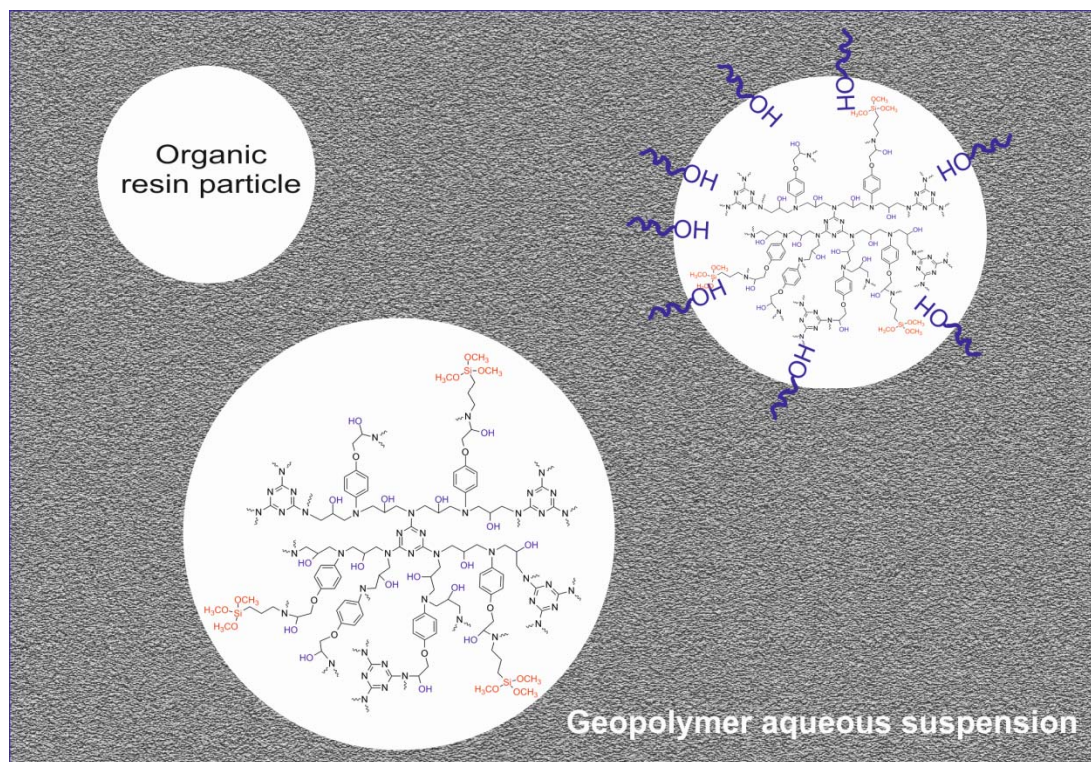

Scheme 1: Rappresentazione schematica delle possibili interazioni fra le particelle di resina con la miscela acquosa geopolimerica appena preparata.

References

- [1] Ferone, C.; Roviello, G.; Colangelo, F.; Cioffi, R.; Tarallo, O. Novel Hybrid Organic-Geopolymer materials, *Applied Clay Science* 2013, 73, 42-50.
- [2] Roviello, G.; Ricciotti, L.; Ferone, C.; Colangelo, F.; Cioffi, R.; Tarallo, G. Synthesis and characterization of novel epoxy geopolymer composites, *Materials*, (2013), 6, 3943-3962.
- [3] Duxson, P.; Provis, J.L.; Lukey, G.C.; van Deventer, J.S.J. The role of inorganic polymer technology in the development of green concrete. *Cem. Concr. Res.* 2007, 37, 1590-1597.
- [4] Davidovits, J. Geopolymer Chemistry and Applications, 3rd ed; Institut Géopolymère: Saint Quentin, France, 2011.

FTIR characterization of nasal polyps lesions

S. Sabbatini¹, E. Giorgini², G. Tosi², C. Conti¹, L. Vaccari³, C. Rubini⁴, M. Re⁵

¹Dipartimento SIMAU, Università Politecnica delle Marche, 60131 Ancona, Italy

²Dipartimento DISVA, Università Politecnica delle Marche, Ancona, Italy

³SISSI Beamline, Elettra Synchrotron Light Laboratory, Trieste, Italy

⁴Dipartimento di Scienze Biomediche e Sanità Pubblica, Università Politecnica delle Marche, Ancona, Italy

⁵Dipartimento di Scienze Cliniche, Specialistiche e Odontostomatologiche, Università Politecnica delle Marche, Ancona, Italy

E-mail: s.sabbatini@univpm.it

ABSTRACT

Nasal polyps are [polypoidal](#) masses arising mainly from the [mucous membranes](#) of [nose](#) and [paranasal sinuses](#). They are freely movable and nontender overgrowths of the mucosa that frequently accompany [allergic rhinitis](#). Usually they show an inflammatory nature, but sometimes they can evolve to tumoral pathologies, with different degree of malignancy. In these cases, there is an objective difficulty in distinguishing inflammatory from benign and malign neoplasia with routinely immunohistochemical assays.

Keywords: infrared spectroscopy, nasal polyps, cluster analysis

On continuing our study of oral cavity tumors, selected sections of nasal polyps and carcinoma have been analyzed by using FPA FTIR Imaging Spectroscopy. The aim of the research is to define spectral biomarkers for a rigorous and objective characterization of the development of this pathology.

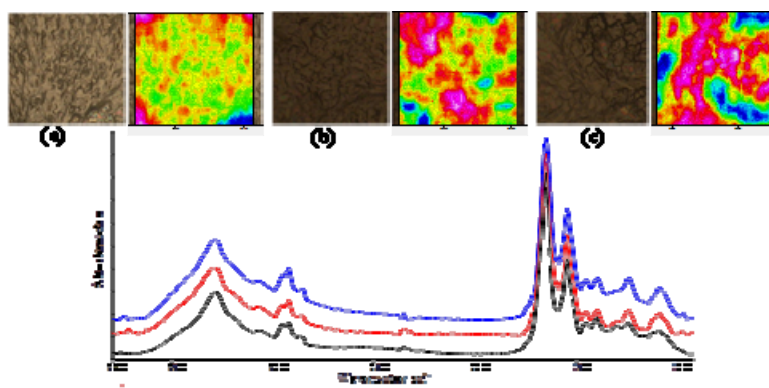

Figure 1: Photomicrographs, chemical maps and average spectra of tissue sections: (a) inflammatory nasal polyp (black); (b) palate (red), and (c) paranasal sinuses (blue) carcinoma.

Evidences of spectral peculiarities between inflammation and carcinoma can be mainly found in the finger print region and averaged could be used as loading standards in custom maps to reconstruct their topological distribution and to verify results from the histopathological analysis.

References

- [1] G. Tosi, P. Balercia, C. Conti, P. Ferraris, E. Giorgini, L. Lo Muzio, S. Sabbatini, D. Stramazotti, C. Rubini *Vibr. Spectrosc.* 57, 140 (2011).
- [2] S. Sabbatini, C. Conti, C. Rubini, V. Librando, G. Tosi, E. Giorgini, *Vibr. Spectrosc.* 68, 196 (2013).

Removal of Arsenic (III) from De-Chlorinated Water by Coagulation-Adsorption Combined Process

Anna Scarlino¹, Daniel A. Sánchez-Rodas Navarro², Giuseppe Mele¹, Domenico Santoro³

¹Department of Engineering for Innovation, University of Salento, Via Arnesano, 73100 Lecce, Italy.

²CIQSO- Center for Research in Sustainable Chemistry. Department of Chemistry and Materials Science, University of Huelva, Avda. Fuerzas Armadas s/n, 21071 Huelva, Spain

³ Department of Chemical and Biochemical Engineering, University of Western Ontario, London, ON N6A 5B9, Canada

Email: anna.scarlino@unisalento.it

ABSTRACT

In natural waters arsenic normally occurs in the oxidation states +III (arsenite) and +V (arsenate). The removal of As(III) is more difficult than the removal of As(V). Therefore, As(III) has to be oxidized to As(V) prior to its removal.

Developing methods for the oxidation of As(III) and cost-effective technologies to remove As from water also drew great attention in the last 20 years. The oxidation in presence of air or pure oxygen is slow, but the oxidation rate can be increased by ozone, chlorine, hypochlorite, chlorine dioxide or hydrogen peroxide. In parallel, the most effective methods to remove arsenic from water are coagulation, adsorption and ion exchange.

Keywords: Arsenic (III), adsorption, coagulation-adsorption

The objective of this work is to evaluate the performance of a combined process, previously used for the removal of wastewater pollutants in a multifunctional reactor [1], to remove arsenic (III) from de-chlorinated water.

In particular, this treatment consists of a combined process of coagulation with aluminum polychloride (AP), adsorption with powder activated carbon (PAC), ions exchange with zeolite (Z) and oxidation with sodium hypochlorite (SH). Laboratory batch experiments, defined by means a Design of Experiments technique known as Latin Square, were performed using de-chlorinated water at pH =8 spiked with starting As (III) concentration ranging from 100 µg/L to 12 µg/L at different mixing speed (500, 1000 and 1400 rpm).

Experimental results indicated that when the mixing speed increases, the arsenic removal improves. In particular, sodium hypochlorite plays a important role in the combined process because oxides As(III) in As(V), that is removed afterwards thanks to synergic effect of aluminum polychloride, power actived carbon and zeolite.

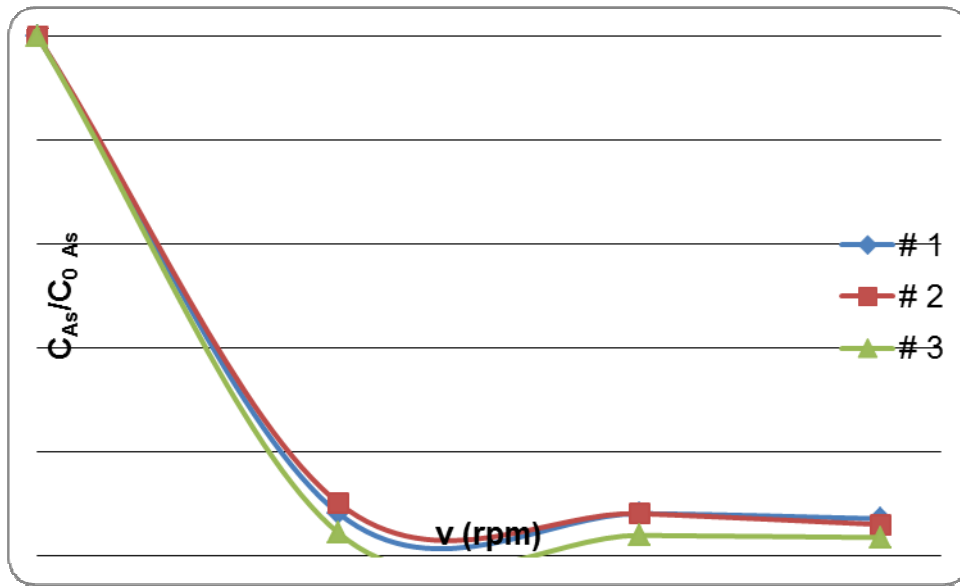

Figure 1: As(III) removal versus mixing speed for the best combinations ($[As]_0=100\mu\text{g/L}$).

Experiment [#]	AP [$\mu\text{L/L}$]	PAC [mg/L]	SH [mg/L]	Z [mg/L]	As (III) removal efficiency (%)
1	150	0	5	0	92.8
2	150	20	7.5	50	94
3	150	30	2.5	100	96.4

Table 1. Observed As (III) removal efficiency with a starting arsenic concentration of $100\mu\text{g/L}$.

Selected results reported in Table 1 showed that the removal process is effective and the As residual concentration does not exceed the required limits in drinking water [2].

References

- [1] O. Santoro, T. Pastore, D. Santoro, F. Crapulli, M. Raisee, M. Moghaddami, *Water Science & Technology*, 68.8, 1715-1722, (2013)
- [2] Guidelines for drinking-water quality, fourth edition, *World Health Organization* (2011)

Metal oxide magnetic nanoparticles for hyperthermia therapy

P. Sgarbossa¹, E. Sieni¹, F. Ceretta¹, F. Spizzo², F. Dughiero¹, M. Forzan¹, R. Michelin¹, R. Bertani¹, M. Mozzon¹

¹Department of Industrial Engineering, University of Padua, Padua, Italy

²Department of Physics and Earth Sciences and CNISM, University of Ferrara, Ferrara, Italy

e-mail: paolo.sgarbossa@unipd.it

ABSTRACT

Nanoflower shaped magnetic nanoparticles were synthesized by thermal decomposition of iron (III) chloride hexahydrate ($\text{FeCl}_3 \cdot 6\text{H}_2\text{O}$) and 2-pyrrolidone. Thermal and magnetic characterization have been performed.

Keywords: magnetic nanoparticles, hyperthermia, iron oxide, thermal decomposition

Hyperthermia is a cancer therapy based on the observation that tumor cells are less resistant to temperature increase than healthy ones [1]. Iron oxide superparamagnetic nanoparticles are studied in depth as hyperthermia agents. SPIONs with diameters of 20-40 nm are able to cross capillary walls and are often phagocytized by macrophages which traffic to the lymph nodes and bone marrow [2]. The heat generated by superparamagnetic iron oxide nanoparticles in an alternating magnetic fields that randomly flips their magnetization orientation direction increases the temperature of the tissues destroying the pathological cells.

In this work nanoflower shaped magnetic nanoparticles were synthesized by a thermal decomposition technique [3] using iron (III) chloride hexahydrate ($\text{FeCl}_3 \cdot 6\text{H}_2\text{O}$) and 2-pyrrolidone as precursor and solvent respectively. We report the thermal and magnetic characterization of the nanoparticles. Moreover, the Specific Absorption Rate (SAR) of a 10 mg/ml of SPIONs in water has been evaluated using a homemade device (Fig. 1).

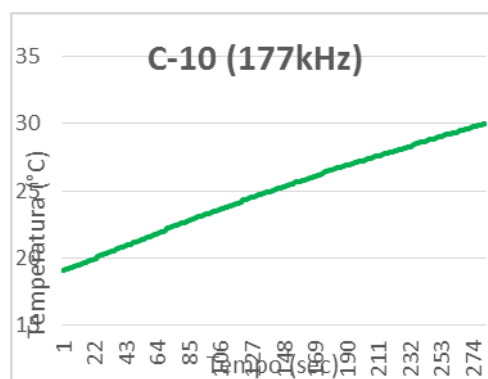
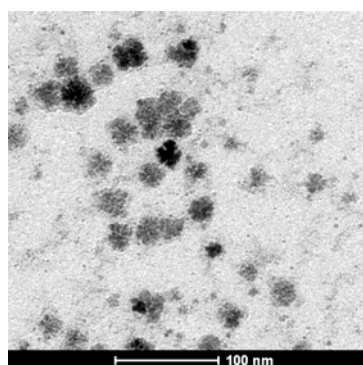

Figure 1: TEM image of magnetic nanoparticles and heating rate at 177 kHz.

References

- [1] Kim, J.; Park, S.; Lee, J. E. et al. *Angew. Chem., Int. Ed.* 2006, 45, 7754-7758.
- [2] Lu, A. H.; Salabas, E. L.; Schult, F. *Angew. Chem., Int. Ed.* 2007, 48, 1222-1244.
- [3] Frey, N. A.; Peng, S.; Cheng, K.; Sun, S. *Chem. Soc. Rev.* 2009, 38, 2532-2542.

Acknowledgements: The authors are grateful to Dr. Federico Caicci, Department of Biology of the University of Padova for the TEM measurements. This work is supported by the grant "Progetto di Ateneo" of the Padova University (CPDA114144).

Production, characterisation and application of manganese oxide-based electrodes for anodica oxidation of organic pollutants

Giovanni Sotgiu¹, Luca Tortora¹, Elisabetta Petrucci², Matteo Foderà², Francesco Marra²

¹Dipartimento di ingegneria, Università di Roma TRE, Via Vito Volterra 62, 00146, Roma

² Dipartimento di Ingegneria Chimica Materiali Ambiente, Università “La Sapienza”, Via Eudossiana 18, 00184, Roma

Email: giovanni.sotgiu@uniroma3.it

ABSTRACT

In this study, preliminary results concerning the fabrication, characterisation and use of manganese oxide thin film electrodes are presented.

Keywords: Manganese oxide, thin-film electrodes, organic pollutants oxidation

Different techniques of deposition were compared in order to obtain better results in anodic oxidation of organic pollutants. In particular, manganese oxide films were produced by cathodic electrodeposition from aqueous KMnO_4 solutions (type A), by anodic electrodeposition from aqueous MnSO_4 solutions (type B) and by thermal decomposition from alcoholic solutions (type C). All the films were growth on titanium foil covered with a thermally deposited ruthenium oxide inter-layer to ensure good electrical contact.

The electrodes were fully characterized by cyclic voltammetry (CV), X-Ray Diffraction (XRD), Scanning Electrode Microscopy (SEM), Energy Dispersive Spectroscopy (EDS), profilometric measurements and ToF-SIMS.

Then, all the electrodes were tested for the treatment of aqueous solutions of the azo dye reactive violet 5 under galvanostatic conditions in an undivided reactor. The azo-dye degradation was evaluated by UV-vis measurements and COD analysis and the results were compared with previous measurements.

All the electrodes, in the presence of small amount of chloride, exhibited good decolorization and COD reduction capability, with type B electrodes faster than the others. The type C electrodes accounted for anodes less performant with negligible formation of active chlorine.

Preliminary analyses of the anionic species evolution showed that the electrogeneration of active chlorine occurred without promoting perchlorate evolution, thus showing interesting potential for applications to discoloration of dye-containing wastewater.

New Pirimidoquinoxaline Nitrones as Radical Scavengers

R. Cipolletti¹, P. Stipa¹, N. Gruber², L. R. Orelli²

¹ SIMAU Department - Chemistry Division, Università Politecnica delle Marche, Via Brecce Bianche 12, 60131 Ancona, Italy

² Dep. de Química Orgánica, Universidad de Buenos Aires, CONICET Junín 956, Argentina

Email: p.stipa@univpm.it

ABSTRACT

New Pirimidoquinoxaline Nitrones have been synthesized and tested as radical scavengers for EPR Spin Trapping experiments. Very persistent hydroperoxyl adducts have been found.

Keywords: Spin Trapping, Electron Paramagnetic Resonance, Free Radicals, DFT

Electron Paramagnetic Resonance (EPR)-Spin Trapping is one of the most reliable techniques for detecting and identifying short-lived free radicals. It is based upon the fast reaction between a suitable diamagnetic molecule (a spin trap) and a transient free radical with formation of a relatively long-lived adduct, whose parameters (h.f.c.c. and *g*-factor) are characteristic of the type

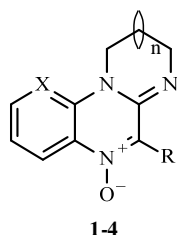

- 1: X= CH, n= 1, R= C₆H₅
- 2: X= CH, n= 1, R= CH₂C₆H₅
- 3: X= CH, n= 0, R= 4-OCH₃C₆H₄
- 4: X= N, n= 1, R= C₆H₅

of the initial radical.[1] Nitrones (N-oxides) represent the most commonly used spin traps [2] and they are continuously object of studies to improve their efficiency and the stability of the corresponding spin adducts. With tis aim a series of 2,3-Dihydro-1*H*-pyrimido[1,2-*a*]quinoxaline-6-oxides (1-4) has been prepared and tested as spin traps by EPR spectroscopy. Although less reactive with respect to

the previously synthesized benzoxazine analogues [3] due to steric hindrance at nitrone α -carbon, all derivatives tested were able to efficiently scavenge all carbon- and oxygen-centered radicals used in this study. However, very persistent HOO radical adducts have been found, likely due to their different possibilities to yield intramolecular H-bonds, as showed by proper DFT studies.

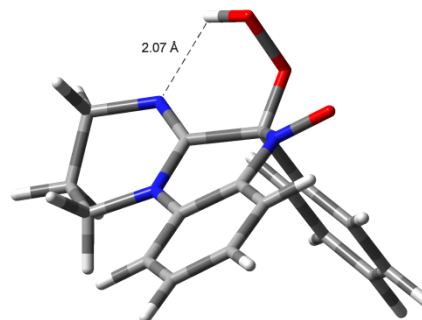
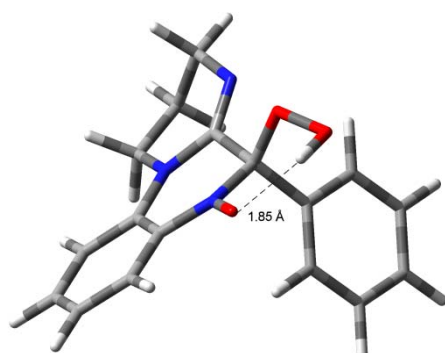

References

- [1] E. G. Janzen, B. J. Blackburn, J. Am. Chem. Soc. 1968, 90, 5909; M. Iwamura, N. Inamoto, Bull. Chem. Soc. Jpn., 1967, 40, 702; A. Mackor, A. J. W. Wajer, J. de Boer, Tetrahedron Lett. 1966, 2115.
- [2] E. G. Janzen, Acc. Chem. Res. 1971, 4, 31; C. A. Evans, Aldrichimica Acta 1979, 12, 23.
- [3] P. Stipa, P. Astolfi, M. Marini, J. Org. Chem. 2007, 72, 8677

Identification and characterization of plastics from small appliances and kinetic analysis of their thermally activated pyrolysis

Stefano Vecchio Cipriotti¹, Lorenzo Cafiero², Riccardo Tuffi², Eugenio Castoldi²

¹ Dept. S.B.A.I., Sapienza University of Rome, Via del Castro Laurenziano 7, 00161 Rome, Italy

²Unità Tecnica Tecnologie Ambientali, ENEA - Casaccia Research Center, Via Anguillarese 301, 00123 S. Maria di Galeria (Rome), Italy

Email: stefano.vecchio@uniroma1.it

ABSTRACT

Three main polymers of the thermoplastic fraction were identified from small appliances: acrylonitrile-butadiene-styrene (ABS) and high impact polystyrene (HIPS) and polybutadiene terephthalate (PBT) in the printed circuit boards. A kinetic analysis of pyrolysis occurring on the three components and on their ternary mixture was performed by thermogravimetry (TG) in argon atmosphere under non-isothermal conditions.

Keywords: WEEE, ABS plastics, pyrolysis kinetics

According to the Statistical Office of the European Union (EUROSTAT), Waste of Electric and Electronic Equipment (WEEE) generated in the European Union (EU) amounts to three times as much as the quantity properly collected and managed in Europe [1]. The plastic fraction contained in WEEE accounts for about 30% [2] and consequently its proper management may give a significant contribution to achieve the EU targets. Thermal techniques in general and pyrolysis in particular allow dealing with the heterogeneity and complex composition of mixed plastics and classifying waste components to be used for energy generation. The novelty and the most important aim of this study is the identification and characterization of the most representative thermoplastic components extracted from WEEE found in small appliances (housing and printed circuit boards, PCB). Another important aim of this investigation is the thermal characterization of these components and their mixture, focusing the attention to the analysis of their pyrolysis kinetics using reliable kinetic methods.

Three of the main housing constituents were identified in the thermoplastic fraction of small appliances: acrylonitrile-butadiene-styrene (ABS), polypropylene (PP) and high-impact polystyrene (HIPS) with percentages of 37, 29 and 19 % w/w respectively. The selected plastic parts came from shredded mixtures of various personal computer brands. FT-IR spectroscopy allowed to identify HIPS in the personal computer external housing and was coded as "PC", ABS in the keyboard case (coded as "Keyb"), and PBT in the RAM slot and was coded as "Black slot". A fourth sample, representative of the WEEE plastics (denoted as "Real WEEE"), was prepared as a ternary mixture of the above-mentioned plastic samples, with a normalized composition based on the commercial analysis reported above (64, 33 and 3 % w/w for Keyb, PC and Black slot, respectively). All four samples undergo a two-step pyrolysis process, the main of which, at lower temperatures, occurs in the temperature range from 663 to 693 K, and is accompanied by a weight loss between 80% and 100%. The second decomposition step concerning PC and Keyb samples may be attributed to the loss of butadiene as generally known. Black slot sample shows on the other side a marked difference in composition with respect to PBT concerning the residue (20% higher than that of PBT). (Fig. 1). The model-free methods adopted in this study use TG data recorder at several heating rates. Because of its easy use, the first method used was that of Kissinger [3], that enable to determine mean values

of E_a (for the whole pyrolysis process) from the slope of the regression line derived by plotting $\ln(\beta_i/T_{m,i}^2)$ vs. $1000/T_m$ according to the following equation:

$$\ln(\beta_i/T_{m,i}^2) = \text{Const} - (E_a/RT_{m,i}) \quad (1)$$

where the subscript i refers to each experiment at a given heating rate β , $T_{m,i}$ corresponds to the maximum reaction rate at each fixed heating rate (α_{\max} , for which $d^2\alpha/dt^2 = 0$), which corresponds to the peak temperature of the first-order derivative of the TG (DTG) curve.

The values of activation energy determined from the slope of Eq. (1) related to the pyrolysis of Keyb, Black slot and Real WEEE are 208 ± 8 , 216 ± 8 and 208 ± 8 kJ·mol⁻¹, respectively. No significant differences can be considered among these values since they fall within the estimated uncertainties, while a higher E_a value (249 ± 8 kJ·mol⁻¹) is found for the process occurring in the PC sample. Excellent agreement is found between these values and the means of the E_a values (E_0) calculated using an isoconversional method (Ozawa-Flynn-Wall [4]).

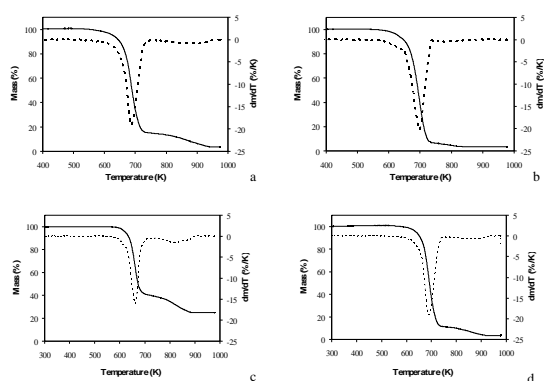

Table 1

Average values of Arrhenius parameters derived by their isoconversional trends.

	E_0 (kJ·mol ⁻¹)	$\ln(A_0/\text{min}^{-1})$
Keyb	198 ± 6	32 ± 1
PC	259 ± 11	43 ± 1
Black slot	210 ± 7	35 ± 1
Real WEEE	214 ± 6	35 ± 1

Figure 1: TG (solid line) and DTG (broken line) curves of WEEE plastic samples at 10 K·min⁻¹ for: a) Keyb, b) PC, c) Black slot, d) Real WEEE

References

- [1] Final proposal COM(2008) 810 for a Directive of the European Parliament and of the Council on waste electrical and electronic equipment (WEEE)
- [2] J. Cui, E. Forssberg, *Journal of Hazardous Materials*, B99, 243-63, (2003).
- [3] H. Kissinger, *Analytical Chemistry*, 29, 1702-6, (1957).
- [3] T. Ozawa, *Bulletin of the Chemical Society of Japan*, 38, 1881-6, (1965).

Valutazione ambientale della sintesi della curcumina tramite parametri quantitativi di "green metrics"

[Elisabetta Zerazion¹](#), [Roberto Rosa²](#), [Erika Ferrari³](#), [Cristina Leonelli²](#), [Anna Corradi⁴](#), [Anna Maria Ferrari¹](#)

¹Dipartimento di Scienze e Metodi dell'Ingegneria, Università degli Studi di Modena e Reggio Emilia, via Amendola 2, 42100 Reggio Emilia

²Dipartimento di Ingegneria "Enzo Ferrari", Università degli Studi di Modena e Reggio Emilia, via Vignolese 905/A, 41125 Modena

³Dipartimento di Scienze Chimiche e Geologiche, Università degli Studi di Modena e Reggio Emilia, via Campi 183, 41125 Modena

⁴ Dipartimento di Economia, Scienze e Diritto, Università della Repubblica di San Marino, Salita alla Rocca 44, 47890 San Marino Città

Email: elisabetta.zerazion@unimore.it; roberto.rosa@unimore.it

ABSTRACT

La curcumina [(1E,6E)-1,7-Bis(4-hydroxy-3-methoxyphenyl)-1,6-heptadiene-3,5-dione] è un composto fenolico presente nei rizomi della pianta *Curcuma longa* L. Essa, così come numerosi suoi derivati, possiede interessanti proprietà antiossidanti, antiinfiammatorie e antitumorali [1]. Per questo motivo la sintesi chimica dei diversi curcuminoidi risulta fondamentale allo scopo di realizzare un accurato studio di tutte le possibili relazioni esistenti tra struttura e proprietà.

Lo scopo di questo lavoro è quello di presentare una dettagliata valutazione ambientale del processo sintetico della curcumina così come messo a punto da alcuni degli autori [2]. Infatti, ultimamente accanto ai tradizionali parametri che accompagnano una sintesi chimica (come resa, tempo di reazione, etc.) sta acquisendo sempre maggiore importanza l'utilizzo dei cosiddetti parametri di *green metrics*, allo scopo di promuovere uno sviluppo sempre più sostenibile, permettendo al chimico organico di scegliere la strategia sintetica meno impattante sull'ambiente e sulla salute umana [3,4].

L'approccio seguito ha previsto l'utilizzo del software EATOS (*Environmental Assessment Tool for Organic Synthesis* [5,6]) e di uno studio tramite metodologia LCA (*Life Cycle Assessment*) [7]. Al contrario del software EATOS (che è limitato alla sola valutazione delle sostanze chimiche coinvolte nella sintesi e nel work-up) l'analisi LCA permette di prendere in considerazione numerose altre categorie potenzialmente impattanti quali i consumi energetici, quelli dovuti al trasporto delle materie prime, agli imballaggi delle sostanze utilizzate, e molti altri, permettendo di realizzare una valutazione dell'intero ciclo di vita del processo "dalla culla alla tomba". I risultati ottenuti permetteranno anche un successivo paragone con il processo estrattivo, così come con le sintesi e le estrazioni che prevedano l'utilizzo di tecniche non convenzionali, come ad esempio il riscaldamento dielettrico a microonde.

Keywords: curcumina, *green metrics*, LCA, EATOS

References

[1] V. Basile, E. Ferrari, S. Lazzari, S. Belluti, F. Pignedoli, C. Imbriano, *Biochem. Pharmacol.* 78, 1305-1315, (2009).

- [2] E. Ferrari, F. Pignedoli, C. Imbriano, G. Marverti, V. Basile, E. Venturi, M. Saladini *J Med Chem* 54, 8066-8077, (2011).
- [3] A. Corradi, C. Leonelli, A. Rizzuti, R. Rosa, P. Veronesi, R. Grandi, S. Baldassari, C. Villa, *Molecules* 12, 1482-1495, (2007).
- [4] D. Ravelli, S. Protti, P. Neri, M. Fagnoni, A. Albinì, *Green Chem.* 13, 1876-1884, (2011).
- [5] M. Eissen, J.O. Metzger, *Chem. Eur. J.* 8, 3581-3585, (2002).
- [6] M. Eissen, J.O. Metzger, EATOS, Environmental Assessment Tool for Organic Syntheses; the software can be obtained free of charge via <http://www.chemie.uni-oldenburg.de/oc/metzger/eatos>.
- [7] S. Hellweg and L. Milà i Canals, *Science*. 344, 1109-1113, (2014)

ToF-SIMS study of gamma-radiation-induced surface modification of silicone breast implants

Luca Tortora^{1,2}, Marco Urbini^{1,2}, Francesco Basoli³, Alberto Rainer³ and Federico Lo Torto⁴

¹ Department of Physics and Mathematics, Surface Analysis Laboratory University of Rome "Roma Tre", Via della Vasca Navale 84, 00146 Rome, Italy;

² Department of Industrial Engineering, University of Rome "Tor Vergata", via del Politecnico 1, 00133 Rome, Italy;

³ Tissue Engineering Laboratory, CIR–Center for Integrated Research, Università Campus Bio-Medico di Roma, via Álvaro del Portillo 21, Rome, Italy;

⁴ Department of Hematology and Plastic, Reconstructive and Aesthetic Surgery, University of Rome "Sapienza", via Álvaro del Portillo 21, Rome, Italy

Email: luca.tortora@uniroma2.it

ABSTRACT

The effect of gamma radiation on chemical, physical and mechanical properties of silicone breast implant was studied. Surface analyses of γ -irradiated polydimethylsiloxane implants were performed by time-of-flight static secondary ion mass spectrometry (ToF-SIMS) technique. A sort of mild depolymerisation of silicone surface was revealed.

Keywords: ToF-SIMS, Silicone, Surface analysis, Biomaterials.

Literature reports how silicone (polydimethylsiloxane) breast implants surface features such as texture, roughness, and chemical composition play key roles in cell adhesion and growth. Indeed, surface texturing of prosthetic implants is exploited for the prevention of capsular contracture. As a result of γ irradiation, silicone undergoes a series of changes due to radiation cross-linking. We studied the textured surface of silicone prostheses irradiated with a radiotherapy dose of 50 Gy. The local surface roughness, as determined by high-resolution profilometry measurements is in the range of 20-30 nm. Untreated and irradiated PDMS prostheses were investigated by TOF-SIMS and multivariate analysis revealed a scission of the polymer main chain and a drop in the abundance of high molecular weight fragments.

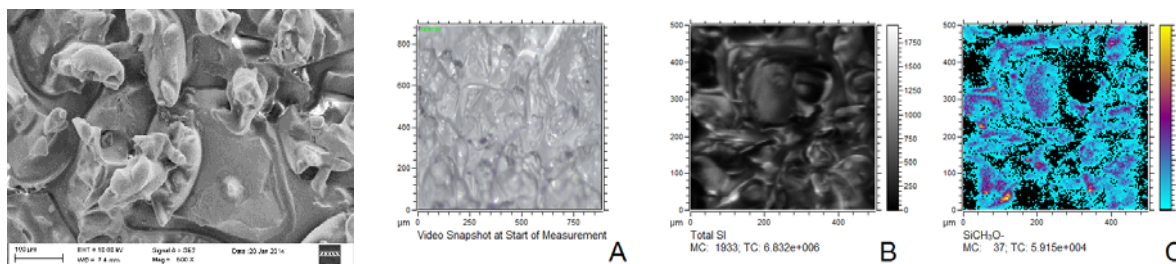

Figure 1: SEM image of the textured surface of an irradiated PDMS breast implant. **Figure 2:** Irradiated silicone A) Optical Microscopy Image; B) Total secondary ion image; C) Distribution of negative secondary ion SiCH₃O⁻ at m/z 58.97.

References

- [1] A. S. Palsule, S. J. Clarson, C. W. Widenhouse, *Journal of Inorganic and Organometallic Polymers and Materials*, 18 (2), 207-221, (2008).

Energy Generation by Salinity Power Gradient - Reverse Electrodialysis (SPG-RE)

Ramato Ashu Tufa¹, Efrem Curcio^{1,2}, Willem van Baak³, Simon Grasman⁴, Enrica Fontananova², Gianluca Di Profio²

¹Department of Environmental and Chemical Engineering, University of Calabria (DIATIC-UNICAL) via P. Bucci Cubo 45A, 87036 Rende (CS) Italy

²Institute on Membrane Technology of the National Research Council (ITM-CNR), c/o University of Calabria Via P. Bucci, Cubo 17/C, 87036 Rende (CS), Italy

³Fujifilm Manufacturing Europe B.V., Oudenstaart 1, 5047 TK Tilburg, The Netherlands

⁴REDstack B.V., Pieter Zeemanstraat 6, 8606 JR Sneek, The Netherlands

Email: efrem.curcio@unical.it

ABSTRACT

We have tested Salinity Power Gradient-Reverse Electrodialysis (SPG-RE) unit for the production of electrical energy by exploiting the chemical potential of real brackish water and exhaust brine from solar pond. The cross flow SPG-RE module (REDstack B.V.), equipped with AEM-80045 and CEM-80050 membranes specifically developed by Fujifilm Manufacturing Europe B.V. within the EU-funded project REAPOWER (“Reverse Electrodialysis Alternative Power Production”), was able to generate a maximum power density of 3.4 W/m² when operated with pure NaCl aqueous solutions (0.1M in low concentration compartment - LCC, 5M in high concentration compartment - HCC) at 20°C and recirculation rate of 20 l/h. However, a drastic reduction to 1.13 W/m² (-63%) was observed when feeding SPG-RE unit with artificial multi-ion solutions mimicking brackish water and exhaust brine from a solar pond. Further experimental activity allowed at identifying Mg²⁺ ions as responsible for the significant increase in stack resistance and consequent depletion of SPG-RE performance. Therefore, specific softening treatment of the real solutions should be considered in order to maintain the process efficiency at practical level.

Keywords: Salinity Power Gradients; Reverse Electrodialysis; Renewable Energy; Ion Exchange Membranes

Acknowledgement

The financial support of European Union through the research project REAPower - “Reverse Electrodialysis Alternative Power Production” (www.reapower.eu) within the EU-FP7 programme (Project No. 256736) is kindly acknowledged.

References

- [1] M. Tedesco, A. Cipollina, A. Tamburini, W. van Baak, G. Micale. Desalination and Water Treatment 49, 404-424, (2012).
- [2] D.A. Vermaas, J. Veerman, N.Y. Yip, M. Elimelech, M. Saakes, K. Nijmeijer, ACS Sustainable Chemistry & Engineering, 1, 1295-1302, (2013).

The effect of cold rolling process on the formability of AISI 301 stainless steels

Marina Delucchi¹, A. Barbucci, M.Panizza, M.P. Carpanese, D. Clematis, G. Cerisola

¹DICCA, University of Genova, P.le Kennedy 1, 16129 Genova, Italy

Email: marina.delucchi@unige.it

ABSTRACT

The aim of this paper was to answer an industrial problem related to the possibility of obtaining a good compromise between tensile strength and formability of cold rolled AISI 301 to be used for cold drawing. Accordingly, the change in the mechanical properties of an austenitic stainless steel subjected to several different processes of cold rolling has been investigated and related to its microstructural changes.

Keywords: cold rolling, deformation-induced martensite formation, 301 SS

The studied materials were austenitic type stainless steels 301 and 301HT4.

Regarding the standard process, the 301 SS coils, 1-0,8 mm thick, are subjected to the following steps: i) full-hard rolling, reducing the sheet thickness to 0,35 mm; ii) continuous bright annealing at 1150°C with a sheet speed of 26 m/min; iii) cold working by 3-4 successive passes through a single stand reversing mill reducing the sheet thickness to 0,2 mm; iv) tension straightening.

During the study some process parameters were varied to evaluate their effect on the final mechanical properties of the 301 SSs, as final sheet thickness, sheet speed in the bright annealing step. And various text have been performed: grain size of the samples; volume fraction of martensite (VFM) phase; tensile test properties; bend-resistance performance (Figure 1).



Figure 1: Device for bending resistance tests

The following remarks can be concluded from the present work: the martensite content determined by Feritoscope measurements was always lower than that of image analysis. This can be attributed to the introduction of strain induced martensite in the surface of the specimens due to their mechanical pretreatment thorough SiC paper; the metastable austenite was transformed to strain induced martensite by cold rolling. Martensite phase was formed in both 301 and 301HT4 SSs, but in higher amounts in the former material, independently of each attempted process; the bend resistance resulted always lower than the desired one, and only when the tensile strength of 301 HT4 SS was below the fixed minimum, it satisfied the requirements; all the attempted variations of the process parameters did not guarantee the fulfilment of all the desired mechanical properties for both AISI 301 and AISI 301 HT4.

References

- [1] Ali Hedayati, Abbas Najafizadeh, Ahmad Kermanpur, Farnoosh Forouzan, *Journal of Materials Processing Technology* 210, 1017-1022, (2010)
- [2] S. F. Peterson, M.S. Thesis, Colorado School of Mines, Golden, CO (1997)

